



NSS evo3

Operator Manual

ENGLISH



Preface

Disclaimer

As Navico is continuously improving this product, we retain the right to make changes to the product at any time which may not be reflected in this version of the manual. Please contact your nearest distributor if you require any further assistance.

It is the owner's sole responsibility to install and use the equipment in a manner that will not cause accidents, personal injury or property damage. The user of this product is solely responsible for observing safe boating practices.

NAVICO HOLDING AS AND ITS SUBSIDIARIES, BRANCHES AND AFFILIATES DISCLAIM ALL LIABILITY FOR ANY USE OF THIS PRODUCT IN A WAY THAT MAY CAUSE ACCIDENTS, DAMAGE OR THAT MAY VIOLATE THE LAW.

Governing Language: This statement, any instruction manuals, user guides and other information relating to the product (Documentation) may be translated to, or has been translated from, another language (Translation). In the event of any conflict between any Translation of the Documentation, the English language version of the Documentation will be the official version of the Documentation.

This manual represents the product as at the time of printing. Navico Holding AS and its subsidiaries, branches and affiliates reserve the right to make changes to specifications without notice.

Trademarks

Navico[®] is a registered trademark of Navico.

Simrad[®] is used by license from Kongsberg.

Navionics[®] is a registered trademark of Navionics, Inc.

NMEA[®] and NMEA 2000[®] are registered trademarks of the National Marine Electronics Association.

SiriusXM[®] is a registered trademark of Sirius XM Radio Inc.

SimNet[®] is a registered trademark of Navico.

Fishing Hot Spots[®] is a registered trademark of Fishing Hot Spots Inc. Copyright© 2012 Fishing Hot Spots.

FUSION-Link[™] Marine Entertainment Standard[™] is a registered trademark of FUSION Electronics Ltd.

C-MAP[®] is a registered trademark of C-MAP.

FLIR[®] is a registered trademark of FLIR.

Mercury[®] is a registered trademark of Mercury.

SmartCraft VesselView[®] is a registered trademark of Mercury.

Suzuki[®] is a registered trademark of Suzuki.

SD[™] and microSD[™] are trademarks or registered trademarks of SD-3C, LLC in the United States, other countries or both.

Wi-Fi[®] is a registered trademark of the Wi-Fi Alliance[®].

Additional mapping data: Copyright© 2012 NSI, Inc.: Copyright© 2012 by Richardson's Maptech.

Bluetooth[®] is a registered trademark of Bluetooth SIG, Inc.

HDMI[®] and HDMI[™], the HDMI Logo, and High-Definition Multimedia Interface are trademarks or registered trademarks of HDMI Licensing LLC in the United States and other countries.

Navico product references

This manual can refer to the following Navico products:

- Broadband Radar[™] (Broadband Radar)
- Broadband 3G[™] Radar (Broadband 3G Radar)
- Broadband 4G[™] Radar (Broadband 4G Radar)

- Broadband Sounder™ (Broadband Sounder)
- DownScan Imaging™ (DownScan)
- DownScan Overlay™ (Overlay)
- ForwardScan™ (ForwardScan)
- GoFree™ (GoFree)
- Halo™ Pulse Compression Radar (Halo Radar)
- INSIGHT GENESIS® (Insight Genesis)
- SonicHub® (SonicHub)
- StructureMap™ (StructureMap)
- StructureScan® (StructureScan)
- StructureScan® HD (StructureScan HD)

Copyright

Copyright © 2016 Navico Holding AS.

Warranty

The warranty card is supplied as a separate document.

In case of any queries, refer to the brand website of your display or system: www.simrad-yachting.com.

Compliance statements

This equipment complies with:

- CE under 2014/53/EU Directive
- The requirements of level 2 devices of the Radio communications (Electromagnetic Compatibility) standard 2008
- Part 15 of the FCC Rules. Operation is subject to the following two conditions: (1) this device may not cause harmful interference, and (2) this device must accept any interference received, including interference that may cause undesired operation.

The relevant Declaration of conformity is available in the product's section at the following website: www.simrad-yachting.com.

Internet usage

Some features in this product use an internet connection to perform data downloads and uploads. Internet usage via a connected mobile/cell phone internet connection or a pay-per-MB type internet connection may require large data usage. Your service provider may charge you based on the amount of data you transfer. If you are unsure, contact your service provider to confirm rates and restrictions.

About this manual

The manual assumes that the user has basic knowledge of navigation, nautical terminology and practices.

Important text that requires special attention from the reader is emphasized as follows:

→ **Note:** Used to draw the reader's attention to a comment or some important information.

⚠ **Warning:** Used when it is necessary to warn personnel that they should proceed carefully to prevent risk of injury and/or damage to equipment/personnel.

Manual version

This manual is written for software version 1.0. The manual is continually updated to match new software releases. The latest available manual version can be downloaded from www.simrad-yachting.com.

Viewing the manual on the screen

The PDF viewer included in the unit makes it possible to read the manuals and other PDF files on the screen. Manuals can be downloaded from www.simrad-yachting.com.

The manuals can be read from a card inserted in the card reader or copied to the unit's internal memory.

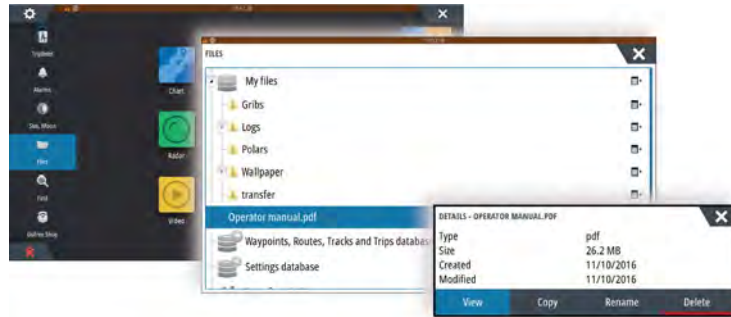

Use the menu options or the keys and on-screen buttons to maneuver in the PDF file as described below:

- Search, Goto page, Page Up and Down
Select the relevant panel button.
- Scroll pages
Turn the rotary knob.
- Panning on the page
Drag finger on the screen in any direction.
- Zoom In/Out
Use pinch or spread gestures.
- Exit the PDF viewer
Press the **X** key or select the **X** in the upper right corner of the panel.

The Software version

The software version currently on this unit can be found in the About dialog. The About dialog is available in the System Settings.

For information regarding upgrading your software, refer to "*Software upgrades*" on page 125.

Contents

10	Introduction
10	Front controls
11	The Home page
11	Application pages
12	Integration of 3 rd party devices
14	Remote controllers
15	Basic operation
15	System Controls dialog
15	Turning the system on and off
15	Display illumination
16	Wireless
16	Locking the touchscreen
16	Instrument bar
16	Touchscreen operation
17	Using menus and dialogs
17	Selecting pages and panels
17	Displaying the Favorites panel as a pop-up on a page
18	Creating a Man Overboard waypoint
18	Screen capture
19	Customizing your system
19	Customizing the Home page wallpaper
19	Configuring the WheelKey
19	Customizing the long press feature
19	Adjusting panel size
20	Password protection
20	Adding new favorite pages
21	Edit favorite pages
21	Setting the appearance of the Instrument bar
22	Bridge Control
25	Charts
25	The Chart panel
25	Chart data
25	Showing dual chart types
26	Panning the chart
26	Chart scale
26	Vessel symbol
26	Positioning the vessel on the chart panel
27	Displaying information about chart items
27	Using the cursor on the chart panel
28	Saving waypoints
28	Creating routes
28	Find objects on chart panels
28	3D charts
29	Chart overlay
29	Insight and C-MAP charts
32	Navionics charts
35	Chart settings
37	Waypoints, Routes, and Tracks
37	Waypoints
38	Routes
40	Tracks
41	Waypoints, Routes, and Tracks dialogs

42	Navigating
42	Navigation panels
43	Navigate to cursor position
43	Navigate a route
44	Navigating with the autopilot
44	Navigation settings
46	TripIntel
46	Current trip statistics
46	Automatic trip recording
47	Start and stop trip recordings
47	Long-term statistics
47	Estimated fuel range ring
47	Fuel gauge
48	Tide gauge
48	View trip recordings
50	Autopilot
50	Safe operation with the autopilot
50	Activating the autopilot
50	Switching from automatic mode to manual steering
50	Autopilot indication on the pages
51	The Autopilot panel
52	Autopilot modes
52	Standby mode
52	Non-Follow Up (NFU, Power steering)
52	Follow-up steering (FU)
52	AUTO mode (auto compass)
53	NoDrift mode
53	NAV mode
54	WIND mode
55	Turn pattern steering
57	Using the NSS evo3 in an AP24/AP28 system
57	Using the autopilot in an EVC system
57	Using the NSS evo3 in an AP70/AP80 system
60	Autopilot settings
63	Radar
63	The radar panel
63	Dual radar
64	Radar overlay
64	Radar operational modes
64	Radar Range
65	Using the cursor on a radar panel
65	Saving waypoints
66	Radar sector blanking
66	Adjusting the radar image
68	Advanced radar options
69	Radar view options
70	EBL/VRM markers
71	Setting a guard zone around your vessel
71	MARPA targets
72	Recording radar data
73	Radar settings
74	Echosounder
74	The Echosounder image
74	Multiple Echosounder

74	Zooming the image
75	Using the cursor on the image
76	Saving waypoints
76	Viewing history
76	Setting up the image
77	Advanced options
78	Start recording log data
79	Stop recording log data
79	Viewing the recorded sounder data
79	Echosounder View options
81	Echosounder settings
83	StructureScan
83	The StructureScan image
83	Zooming the StructureScan image
84	Using the cursor on the StructureScan panel
84	Saving waypoints
85	Viewing StructureScan history
85	Setting up the StructureScan image
86	Advanced StructureScan settings
87	StructureMap
87	The StructureMap image
87	Activating Structure overlay
87	StructureMap sources
88	StructureMap tips
88	Recording StructureScan data
88	Using StructureMap with mapping cards
88	Structure options
90	ForwardScan
90	The ForwardScan image
91	Setting up the ForwardScan image
91	ForwardScan view options
91	Heading extension
92	ForwardScan setup
95	Wireless connection
95	Connect and disconnect from a wireless hotspot
95	GoFree Shop
95	GoFree Link
96	Uploading log files to Insight Genesis
97	Wireless settings
98	AIS
98	AIS target symbols
98	Viewing information about AIS targets
99	Calling an AIS vessel
99	AIS SART
100	Vessel alarms
101	Vessel settings
103	Instrument panels
103	Dashboards
103	Customizing the Instruments panel
104	Audio
104	Enabling audio

- 104 SonicHub 2
- 106 The Audio panel
- 107 Setting up the audio system
- 107 Operating the audio system
- 108 Favorite channels
- 108 Sirius radio (North America only)

109 Weather

- 109 Wind barbs
- 109 Showing weather details
- 109 GRIB weather
- 111 SiriusXM weather
- 114 Weather alarms

115 Video

- 115 The Video panel
- 115 Setting up the video panel
- 115 FLIR camera control

117 Time plots

- 117 The Time plot panel
- 117 Selecting data

118 Alarms

- 118 Alarm system
- 118 Type of messages
- 118 Single alarms
- 118 Multiple alarms
- 118 Acknowledging a message
- 118 Alarms dialog

120 Tools

- 120 Waypoints
- 120 Tides
- 120 Alarms
- 120 Vessels
- 120 Triptel
- 120 Sun, Moon
- 120 Files
- 121 Find
- 121 GoFree Shop

122 Simulator

- 122 Demo mode
- 122 Simulator source files
- 122 Advanced simulator settings

124 Maintenance

- 124 Preventive maintenance
- 124 Cleaning the display unit
- 124 Cleaning the media port door
- 124 Checking the keys
- 124 Checking the connectors
- 124 NMEA Data logging
- 125 Software upgrades
- 126 Backing up your system data

1

Introduction

Front controls

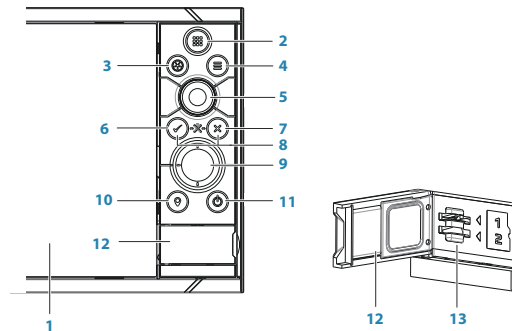

1 Touch screen

2 Pages/Home - press to open the Home page for page selection and setup options

3 WheelKey - user configurable key, refer to "*Configuring the WheelKey*" on page 19.

Default without an autopilot connected to the system:

- Short press: toggles between panels on split screen
- Long press: maximizes active panel on split screen

Default with an autopilot connected to the system:

- Short press: opens the autopilot controller and puts the autopilot in standby mode
- Long press: toggles between panels on split screen

4 Menu key - press to display the active panel's menu

5 Rotary knob - turn to zoom or scroll the menu, press to select an option

6 Enter key - press to select an option or to save settings

7 Exit key - press to exit a dialog, return to previous menu level, and clear the cursor from the panel

8 MOB - press simultaneously the **Enter** and **Exit** keys to create a MOB at the vessel's position

9 Arrow keys - press to activate the cursor or to move the cursor
Menu operation: press to navigate through menu items and to adjust a value

10 Mark key - press to place waypoint at vessel position or at cursor position when cursor is active

11 Power key - press and hold to turn the unit ON/OFF
Press once to display the System Controls dialog, additional presses to toggle through three default dimming levels

12 Card reader door

13 Dual card reader slots

The Home page



1 Applications

Select a button to display the application as a full page panel.
Press and hold a button to display pre-configured split page options for the application.

2 Settings button

Select to access Settings dialogs.

3 Tools

Select a button to access dialogs used for carrying out a task, or for browsing stored information.

4 Favorites

Select a button to display the panel combination.
Press and hold a favorite button to enter edit mode for the Favorites panel.

5 Close button

Select to exit the **Home** page and return to the previous active page.

6 Power button

Select to power off the unit.

7 Man Over Board (MOB) button

Select to save a Man Over Board (MOB) waypoint at the current vessel position.

Application pages

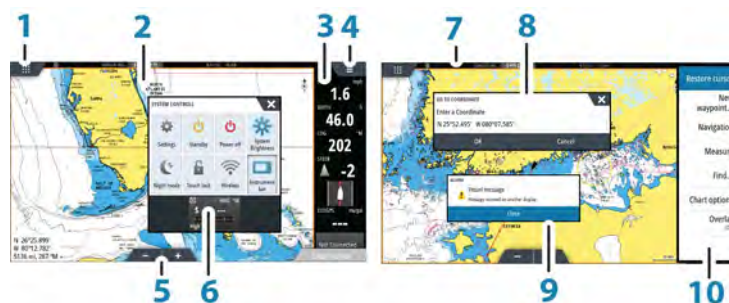

Each application connected to the system is presented on panels. The application can be presented as a full page, or in combination with other panels in a multiple panel page. All application pages are accessed from the **Home** page.

- 1 Home button**
- 2 Application panel**
- 3 Instrument bar**
Navigation and sensor information. The bar can be turned off and it can be configured by the user.
- 4 Menu button**
- 5 Zoom buttons**
- 6 System controls dialog**
Quick access to basic system settings.
Display the dialog by a short press on the **Power** key or by swiping down from top of the screen.
- 7 Status bar**
- 8 Dialog**
Information to or input from the user.
- 9 Alarm message**
Displayed if dangerous situations or system faults occur.
- 10 Menu**
Panel specific menu.

Split pages

You can have up to 4 panels on each page.

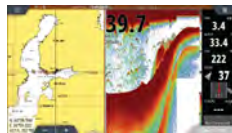

2 panels page

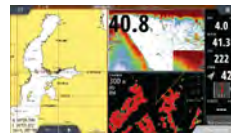

3 panels page



4 panels page

Panel sizes in a split page can be adjusted from the **System Controls** dialog.

Pre-configured split pages

Each full screen application has several pre-configured split pages, featuring the selected application combined with each of the other panels.

→ **Note:** The number of pre-configured split pages cannot be changed, and the pages cannot be customized or deleted.

Access a pre-configured split page by pressing and holding the main panel button.

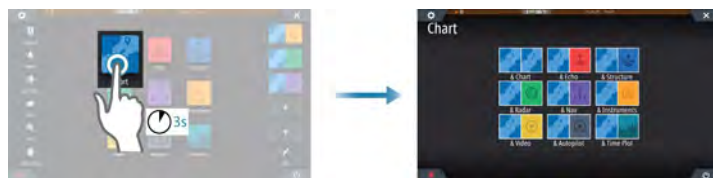

Favorite pages

All preconfigured favorite pages can be modified and deleted, and you can create your own. You can have a total of 12 favorite pages.

For more information, refer to "Adding new favorite pages" on page 20.

Integration of 3rd party devices

Several 3rd party devices can be connected to the NSS evo3. The applications are displayed on separate panels or integrated with other panels.

A device connected to the NMEA 2000 network should automatically be identified by the system. If not, enable the feature from the advanced option in the System settings dialog. The 3rd party device is operated by using menus and dialogs as on other panels. This manual does not include specific operation instructions for any 3rd party device. For features and functionality, refer to the documentation included with the 3rd party device.



SmartCraft VesselView integration

SmartCraft data can be displayed and interaction are enabled through the unit when a Mercury VesselView® 4, 7, 403, 502, 702, 703, or Link is present on the network.

When the features are enabled, the display may prompt the user for some basic configuration information. Refer to the VesselView® manual or engine supplier for further information.

The engine supplier icon appears on the **Home** page when a device is available.



Suzuki Engine panel

If a Suzuki C10 gauge is available on the network, a Suzuki engine icon is added to the **Home** page. An icon is also added to the Page editor. You can select to display the Suzuki engine panel as a full page panel or as part of a multi-panel page.

The layout and content of the engine panel depends on selected panel size. The digital gauges can be customized, refer to *"Customizing the panel"* on page 103.

FUSION-Link integration

FUSION-Link devices connected to the NMEA 2000 network can be controlled from the NSS evo3 system.

The FUSION-Link devices appear as additional sources when using the audio function. No additional icons are available.

Refer to *"Audio"* on page 104 for more information.

FLIR camera integration

If a FLIR M-series camera is available on the Ethernet network, you can display the video and control the camera from the NSS evo3.

The FLIR camera is controlled from the Video panel, and no additional icons appear on the Home page.

Refer to *"Video"* on page 115 for more information.



BEP CZone integration

The NSS evo3 integrates with BEP's CZone system used for controlling and monitoring a distributed power system on your vessel.

The CZone icon is available in the Tools panel on the **Home** page when a CZone system is available on the network.

A separate manual is provided with your CZone system. Refer to this documentation and to the NSS evo3 Installation manual for how to install and configure the CZone system.

CZone dashboard

When the CZone is installed and configured, an additional CZone dashboard is added to the Instruments panels.



Vessel dashboard

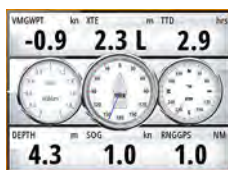

Navigation dashboard

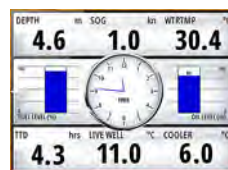

Angler dashboard

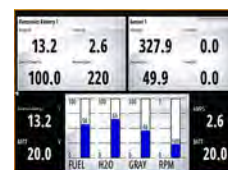

CZone dashboard

You switch between a panel's dashboards by selecting the left and right arrow symbols or by selecting the dashboard from the menu.

Editing a CZone dashboard

You can customize a CZone dashboard by changing the data for each of the gauges. Available editing options depend on the type of gauge and which data sources that are connected to your system.

For more information, refer to "*Instrument panels*" on page 103.

Remote controllers

You can connect a remote controller to the network and remotely control the unit. To find out which remote controllers can be used, refer to the product web page at:

www.simrad-yachting.com.

A separate manual is included with the remote controller.

2

Basic operation

System Controls dialog

The System Controls dialog provides quick access to basic system settings. You display the dialog by making a short press on the **Power** key or by swiping down from the top of the screen.

The icons displayed on the dialog can vary. For example, the adjust splits option is only available if you are viewing a split page when you open the **System Controls** dialog.



Activating functions

Select the icon of the function you want to set or toggle on or off. For those functions that toggle on and off, a highlighted icon indicates the function is activated, as shown in the Instrument bar icon above.

Turning the system on and off

You turn the system off by pressing the **Power** key, or by selecting the **Power** option on the Home page or in the **System Controls** dialog.

If the **Power** key is released before the shut-down is completed, the power off process is cancelled.

→ **Note:** If the unit is configured as a slave, you cannot power off the unit by the **Power** key, and the **System Controls** dialog does not display the power off option.



First time startup

When the unit is started for the first time, or after a factory default, the unit displays a setup wizard. Respond to the setup wizard prompts to select some fundamental setup options.

You can perform further setup using the system settings option and later change settings made with the setup wizard.

Standby mode

In Standby mode, the backlight for screen and keys are turned off to save power. The system continues to run in the background.

You select Standby mode from the **System Controls** dialog.



Display illumination

Brightness

The display backlighting can be adjusted at any time from the **System Controls** dialog.

You can also cycle the preset backlight levels by short presses on the **Power** key.



Night mode

The night mode option optimizes the color palette and backlight for low light conditions.

→ **Note:** Details on the chart may be less visible when the Night mode is selected!



Wireless

Provides wireless connection options dependent on the status of the wireless. For example, connect to a hotspot or change to access point. For option explanations refer to "*Wireless connection*" on page 95.

Locking the touchscreen

You can temporarily lock a touchscreen to prevent accidental operation of the system. Lock the touchscreen when large amounts of water are on the screen, for example, in heavy seas and weather. This feature is also useful when cleaning the screen while the unit is turned on. When the touch lock is active you can only operate the unit from the keys.

You lock the touchscreen from the **System Controls** dialog.

You remove the lock function by a short press on the **Power** key.

Instrument bar



Toggles the Instrument bar on/off for the current page only.

Touchscreen operation

Basic touchscreen operation on the different panels is shown in the table below.

The panel sections in this manual have more information about panel specific touchscreen operation.

Icon	Description
	Tap to: <ul style="list-style-type: none"> • Activate a panel on a multi-panel page • Position the cursor on a panel • Select a menu and a dialog item • Toggle a checkbox option on or off • Show basic information for a selected item
	Press and hold: <ul style="list-style-type: none"> • On any panel with a cursor to either activate the cursor assist feature or open the menu. Refer to "<i>Customizing the long press feature</i>" on page 19 • On the Instrument panel to open the Choose data dialog • On a panel button to see available split screen options • On a favorite button to enter edit mode
	Scroll through a list of available options without activating any option.
	Flick to quickly scroll through e.g. the waypoint list. Tap the screen to stop the scrolling.
	Pan to position a chart or Echosounder image on the panel.

Icon	Description
	Pinch to zoom out on the chart or on an image.
	Spread to zoom in on the chart or on an image.

Using menus and dialogs

Menus

You display a page menu by selecting the **MENU** button in the upper right corner of the page.

- Activate a menu item and toggle on/off an option by selecting it
- Adjust a slide bar value by either:
 - dragging the slide bar
 - selecting the **+** or **-** icons

You can also operate the menus by using the rotary knob:

- Turn the knob to scroll through menu items
- Press the knob to select a highlighted item
- Turn the knob to adjust the value of a selected item

Select the **Back** menu option or the **X** key to return to the previous menu level, and then exit.

The status of the cursor (active vs. inactive) changes the menu options.

Dialog boxes

You select entry fields and keys in a dialog box by tapping the screen or by using the rotary knob.

Numeric and alphanumeric keyboards are automatically displayed when required for entering user information in dialogs. You operate the keyboard by selecting the virtual keys, and you confirm your entry by selecting the virtual **Enter** key or by pressing the rotary knob.

A dialog is closed by saving or cancelling the entry.

A dialog can also be closed by selecting the **X** in the dialog's upper right corner or by pressing the **X** key.

Selecting pages and panels

Selecting a page

- Select a full page panel by selecting the relevant application button on the **Home** page
- Select a favorite page by selecting the relevant favorite button
- Select a predefined split panel by pressing and holding the relevant application icon

Select active panel

In a multiple panel page, only one panel can be active at a time. The active panel is outlined with a border.

You can only access the page menu of an active panel.

You activate a panel by tapping it.

Displaying the Favorites panel as a pop-up on a page

You can display the Favorites panel as a pop-up on any page by pressing and holding the **Home** key.

Select a favorites page in the pop-up to display it. The panel will switch to the selected favorite after 3 seconds.

Creating a Man Overboard waypoint

If an emergency situation should occur, you can create a Man Overboard (MOB) waypoint at the vessel's current position by selecting the **MOB** button on the **Home** page.

You can also save a Man Overboard (MOB) waypoint at the vessel's current position by pressing the **Enter** and **Exit** keys simultaneously. Simultaneous pressing the Enter and Exit keys creates a MOB at the vessel's location

When you activate the MOB function the following actions are automatically performed:

- a MOB waypoint is created at the vessel's position
- the display switches to a zoomed chart panel, centered on the vessel's position
- the system displays navigation information back to the MOB waypoint

Multiple MOB waypoints are saved by repeatedly pressing the **MOB** buttons. The vessel continues to show navigation information to the initial MOB waypoint. Navigation to subsequent MOB waypoints needs to be done manually.

Cancel navigation to MOB

The system continues to display navigational information towards the MOB waypoint until you cancel the navigation from the menu.

Delete a MOB waypoint

1. Select the MOB waypoint to activate it
2. Tap the MOB waypoint's pop-up or press the **Enter** key or the rotary knob to display the MOB waypoint dialog
3. Select the delete option in the dialog.

A MOB waypoint can also be deleted from the menu when it is activated.

Screen capture

Simultaneously press the **Home** and **Power** keys to take a screen capture. Screen captures are saved to internal memory.

You need to turn on the Screen capture option in the System Settings dialog to be able to take a screenshot on a touch screen. When the function is activated, you can take a screenshot on a touch screen by double-selecting the title bar of an open dialog, or by double-selecting the status bar if no dialog is open.

To view files, refer to *"Files"* on page 120.



3

Customizing your system

Customizing the Home page wallpaper

The Home page's wallpaper can be customized. You can select one of the pictures included with the system, or you can use your own picture in .jpg or .png format.

The images can be available on any location that can be seen in the files browser. When a picture is chosen as the wallpaper, it is automatically copied to the Wallpaper folder.

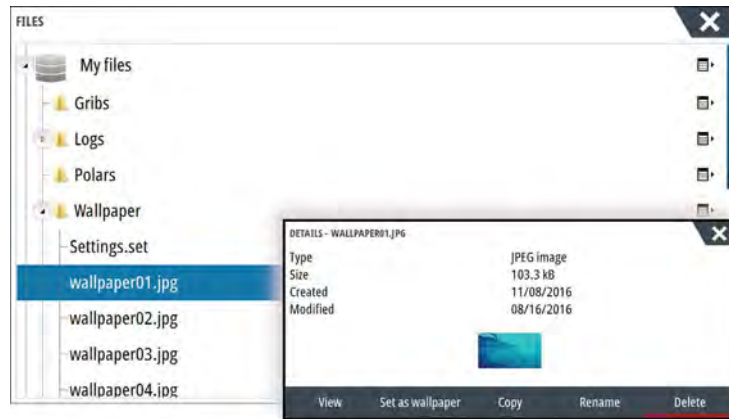
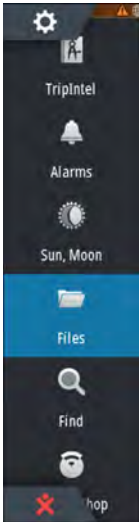

Configuring the WheelKey

You can define what happens with a short or long press of the WheelKey on the front of the unit.

To configure the Wheel key, select **Configure WheelKey** on the System Setting dialog. Select the **Short press** option or **Long press** option in the WHEELKEY CONFIGURATION dialog and then an option from the list displayed.

Customizing the long press feature

Use the **Advanced settings** dialog to specify if the long press on the panel opens the menu or displays the cursor assist feature on the panel.

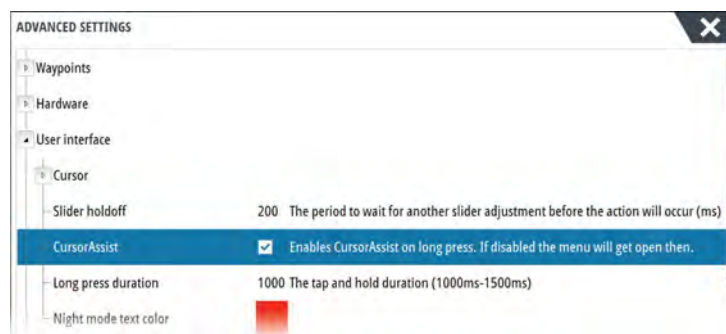

Adjusting panel size

You can change the panel size for an active split page. The panel size can be adjusted for both favorite pages and for predefined split pages.

1. Activate the **System Controls** dialog
2. Select the adjust splits option in the dialog
3. Adjust the panel size by dragging the adjustment icon
4. Confirm your changes by tapping one of the panels, by pressing the rotary knob or the **Enter** key.



The changes are saved to the active favorite or split page.

Password protection

You can set a PIN code to prevent unauthorized access to your system settings.

Note: We recommend you record the PIN code (password) and store it in a safe place if you use this feature.

When you establish password protection, the PIN code must be entered when any of the following are selected. After the correct PIN code is entered, all of them can be accessed without re-entering the PIN code.

- Settings, activated from the Tools panel or System Controls dialog
- Alarms, activated from the Tools panel
- Files, activated from the Tools panel
- GoFree Shop, activated from the Tools panel
- Settings, activated from the Chart menu under Chart Options

You set and remove password protection from the system Settings dialog.

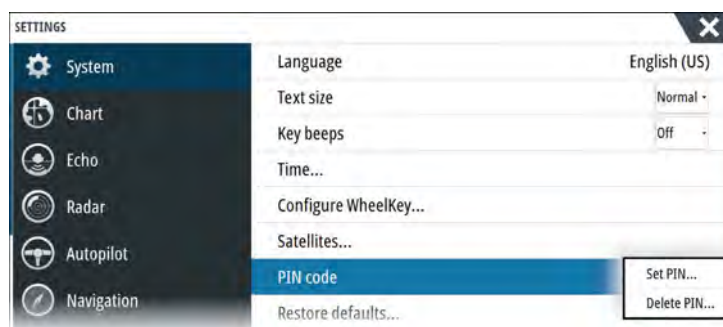

Adding new favorite pages

1. Select the **New** icon in the favorite panel on the **Home** page to open the page editor dialog
2. Drag and drop page icons to set up a new page
3. Change the panel arrangement (only possible for 2 or 3 panels), if required
4. Save the page layout.



The system displays the new favorite page, and the new page is included in the list of favorite pages on the **Home** page.



Edit favorite pages



1. Select the edit icon in the Favorite panel:
 - Select the X icon on a favorite icon to remove the page
 - Select the tool icon on a favorite icon to display the page editor dialog
2. Add or remove panels in the page editor dialog
3. Save or discard your changes to leave the favorite edit mode.

Setting the appearance of the Instrument bar

Data sources connected to the system can be viewed in the Instrument bar.

You can configure the Instrument bar to display either one or two bars. If you specify to display two bars you can set it to alternate the bars automatically. You can specify the information displayed in the instrument bars.

Use the menu to select a predefined activity for one or both of the bars. When an activity bar is selected, predefined instrument gauges are displayed in the instrument bar.

You can turn the Instrument bar off from the **System controls** dialog.

→ **Note:** This only turns the Instrument bar off for the current page.

Turning the Instrument bar on/off

1. Activate the **System controls** dialog
2. Deactivate/activate the instrument bar icon to toggle the bar on and off.

Select a predefined activity bar

1. Activate the Instrument bar by selecting it
2. Select the **MENU** button to open the menu
3. Select **Bar 1** or **Bar 2** and then a predefined activity bar.

Predefined gauges are displayed in the instrument bar. You can change a gauge in the activity Instrument bar, refer to Edit the content of the Instrument bar below.

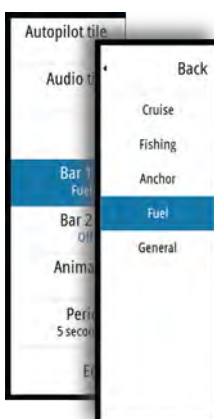

Edit the content of the Instrument bar

1. Activate the Instrument bar by selecting it
2. Select the **MENU** button to open the menu
3. Select **Edit** to change an instrument gauge followed by the gauge you want to change
4. Select the content you want to display from the Choose Data dialog
5. Select **Menu** and then **Finish editing** to save your changes.

Fuel economy gauge

You can display a fuel economy gauge in the instrument bar on application pages (Chart, Radar, Echo, Nav, and so on). Select the predefined Fuel activity bar or change a gauge source to Fuel Economy. To change a gauge source, refer to *"Setting the appearance of the Instrument bar"* on page 21.



- 1 Digital readout of current economy
- 2 Fuel economy measurement units
- 3 100% efficiency, this equates to the 'nominal consumption'
- 4 120% efficiency
- 5 Average fuel economy
- 6 Instantaneous economy
- 7 Current fuel level

The fuel economy gauge displays the instantaneous versus historical average fuel efficiency. The start of the green zone represents 'Nominal Fuel Economy', and it displays an additional 20% area to allow your fuel efficiency to be displayed above the nominal fuel economy.

The more efficient you consume fuel, the more the outer blue dial creeps up towards the green portion of the scale. If you achieve the nominal efficiency of your vessel you will be at the green zone. If you manage to achieve an efficiency better than your nominal efficiency, you will be somewhere in the upper green zone.

Nominal fuel economy can be entered in the Vessel Setup dialog displayed from the Fuel settings dialog.

You can reset your average fuel economy from the Reset Fuel Economy button on the Fuel settings dialog. When you reset it, the system starts calculating the new average.

Set the measurement units for the fuel economy gauge in the Economy field in the Units settings dialog.

Bridge Control

The Bridge Control feature allows you to control which pages are shown on several displays at the same time. The feature is used on vessels with multiple displays mounted in the same place to quickly configure what information is displayed.

There can be a maximum of four different bridges on your system, and you can have up to four displays grouped into one bridge. Each display can be configured to only one bridge.

When the displays are included in a bridge, you can configure twelve page configurations (presets) for each bridge.

Adding displays to a Bridge

→ **Note:** All displays must be turned on to be available for bridge configuration.

1. Open the **Bridge Configuration** dialog

2. Select to configure a new bridge or to edit an existing
 - The **Bridge Configuration** for the selected bridge will be shown, and all displays that are not already assigned to a bridge will be listed
3. Select the display you want to add to the bridge
 - Arrange the displays from left to right in the same physical layout as the displays on your current bridge/dashboard/helm
4. Rename the bridge if required
5. Save the configuration

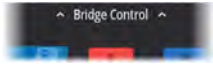

Bridge Control will be displayed on the **Home page** of all units that are configured for a bridge.

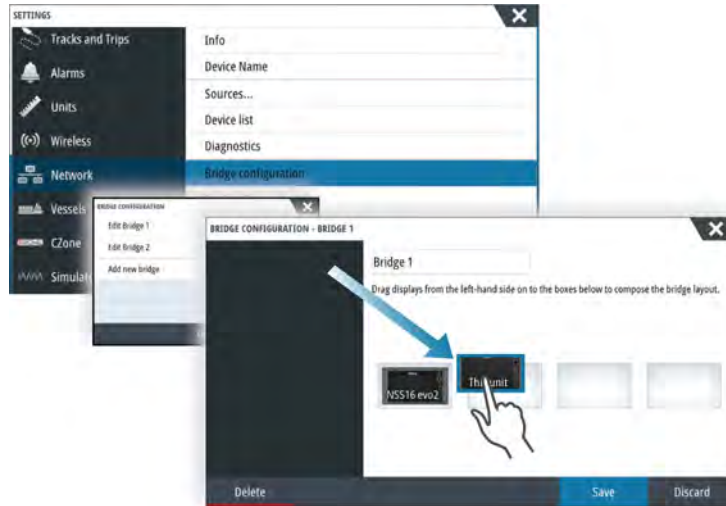

Configuring the preset pages for displays in a bridge

1. Activate the Bridge Control panel by swiping down on **Bridge Control** on the **Home** page
2. Enter edit mode by selecting the edit icon
3. Select the display for which you want to define the preset page
 - The page layout option for the selected display will be read from the network, showing main features and configured favorite pages
4. Select the preferred page
 - Select the blank page if you do not want that display to be included in the selected **Bridge preset**
5. Repeat step 3 and 4 until a page is configured for all displays in all **Bridge presets**
6. Select the edit icon again to leave the edit mode and to save your configuration



Selecting Bridge presets

You display an overview of available **Bridge presets** by swiping down on **Bridge Control** on the **Home** page.

When you select one of the preset configurations all devices included in that bridge will switch to the pre-configured pages.



4

Charts

The chart function displays your vessel's position relative to land and other chart objects. On the chart panel you can plan and navigate routes, place waypoints, and display AIS targets.

The Chart panel

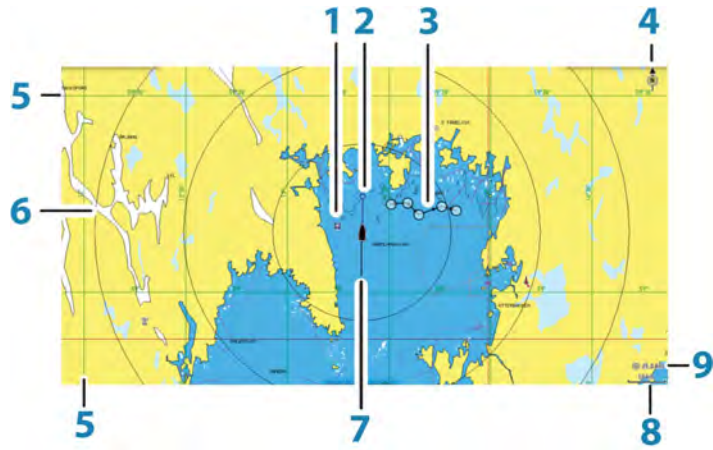

- 1 Waypoint*
- 2 Vessel with extension line (extension line is optional)
- 3 Route*
- 4 North indicator
- 5 Grid lines*
- 6 Range rings*
- 7 Track*
- 8 Chart range scale
- 9 Range rings interval (only displayed when Range rings are turned on)

* Optional chart items. You turn the optional chart items on/off individually from the Chart settings dialog.

Chart data

The system is delivered with different embedded cartography depending on region.

All units support Insight charts from Navico including Insight Genesis. The system also supports charts from Navionics and C-MAP as well as content created by a variety of third party mapping providers in the AT5 format. For a full selection of available charts, visit www.gofreeshop.com, www.c-map.com, or www.navionics.com.

→ **Note:** In this manual, all possible chart menu options are described. These options vary depending on the chart you are using.

Charts on chart cards are shared over the Ethernet network, so only one chart card per vessel is required.

→ **Note:** The system does not automatically switch to embedded cartography if the chart card is removed. A low-resolution chart will be displayed until you re-insert the card or manually switch back to the embedded cartography.

Showing dual chart types

If you have different chart types available - embedded, in the card slot, or on the Ethernet network - you can show two different chart types simultaneously on a page with two chart panels.

You can select a dual chart panel by pressing and holding the Chart application button on the **Home** page, or by creating a favorite page with two chart panels.

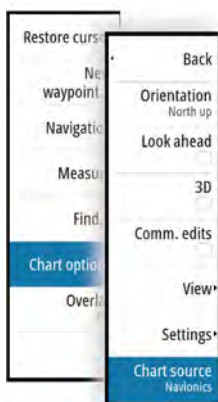

Selecting chart type

You specify the chart type in the Chart panel by selecting one of the available chart types in the chart source menu option.

If you have a multiple Chart panel, the chart type is set individually for each chart panel. Activate one of the chart panels, and then select one of the available chart types in the chart source menu option. Repeat the process for the second chart panel, and select an alternative chart type for this panel.

If you have identical charts available - built in, in the card slot or on the Ethernet network - the system automatically selects the chart with most chart details for your displayed region.

Panning the chart

You can move the chart in any direction by dragging your finger on the screen.

Select the **Clear cursor** menu option or press the **X** key to remove the cursor and cursor window from the panel. This also centers the chart to the vessel position.

Chart scale

You zoom in and out on the chart by using the zoom panel icons, the rotary knob, or by using 2 fingers to pinch (zoom out) and spread (zoom in).

Chart range scale and range rings interval (when turned on) are shown in the lower right corner of the chart panel.



Vessel symbol

When the system has a valid GPS position lock, the vessel symbol indicates vessel position. If no GPS position is available, the vessel symbol includes a question mark.

Positioning the vessel on the chart panel

Chart orientation

Several options are available for how the chart is rotated in the panel. The chart orientation symbol in the panel's upper right corner indicates the north direction.

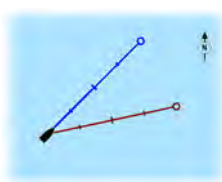

North up

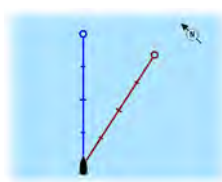

Heading up

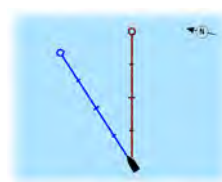

Course up

North up

Displays the chart with north upward.

Heading up

Displays the chart with the vessel's heading directed upward. Heading information is received from a compass. If heading is not available, then the COG from the GPS is used.

Course up

Displays the chart with the direction the vessel is ACTUALLY traveling directed upward, which in some cases is not the direction the vessel is headed.

Look ahead

Moves the vessel icon closer to the bottom of the screen so that you can maximize your view ahead.

Displaying information about chart items

When you select a chart item, a waypoint, a route, or a target, basic information for the selected item is displayed. Select the chart item's pop-up to display all available information for that item. You can also activate the detailed information dialog from the menu.

- **Note:** If you are viewing applicable C-MAP charts on your system, you can select marine objects to display information about services and available multimedia (photos) associated with the location or object.
- **Note:** Pop-up information has to be enabled in chart settings to see basic item information.



Using the cursor on the chart panel

By default, the cursor is not shown on the chart panel.

When you activate the cursor, the cursor position window is displayed. When the cursor is active, the chart does not pan or rotate to follow the vessel.

Press the **X** key or select the **Clear cursor** menu option to remove the cursor and the cursor window from the panel. This also centers the chart to the vessel position.

Select the **Restore cursor** menu option to display the cursor in its previous location. The **Clear cursor** and **Restore cursor** options are useful features for toggling between the vessel's current location and the cursor position.

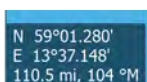

GoTo cursor

You can navigate to a selected position on the image by positioning the cursor on the panel, then using the **Goto Cursor** option in the menu.

The cursor assist function

- **Note:** The cursor assist function is available if it is enabled. Refer to "*Customizing the long press feature*" on page 19.

The cursor assist function allows for fine tuning and precision placement of the cursor without covering details with your finger.

Activate the cursor on the panel, then press and hold your finger on the screen to switch the cursor symbol to a selection circle, appearing above your finger.

Without removing your finger from the screen, drag the selection circle to the desired position.

When you remove your finger from the screen the cursor reverts to normal cursor operation.

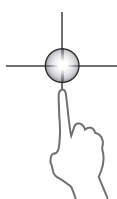

Measuring distance

The cursor can be used to measure the distance between your vessel and a selected position, or between 2 points on the chart panel.

1. Position the cursor on the point from where you want to measure the distance. Start the measure function from the menu
 - The measuring icons appear with a line drawn from the vessel center to the cursor position, and the distance is listed in the cursor information window.
2. You can reposition the measuring points by dragging either icon as long as the measuring function is active

- **Note:** The bearing is always measured from the grey icon to the blue icon.

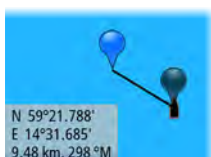

You can also start the measuring function without an active cursor. Both measuring icons are then initially located at the vessel position. The grey icon follows the vessel as the vessel moves, while the blue icon remains at the position given when you activated the function. You terminate the measuring function by selecting the **Finish measuring** option or by pressing the **X** key.

Saving waypoints

A waypoint is saved at the cursor position if active or at the vessel's position if the cursor is not active on the panel, by doing the following:

- Pressing the rotary knob
- Pressing the **Mark** key
- Using the new waypoint option in the menu

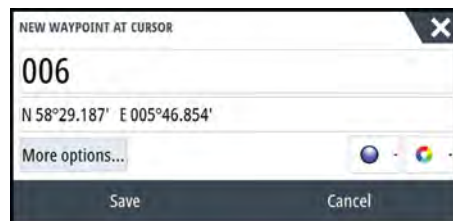

Creating routes

You can create routes as follows on the chart panel.

1. Position the cursor on the chart panel
2. Select **New** followed by **New route** in the menu
3. Tap the chart panel to position the first routepoint
4. Continue positioning the remaining routepoints
5. Save the route by selecting the save option in the menu.

→ **Note:** For more information, refer to "*Waypoints, Routes, and Tracks*" on page 37.

Find objects on chart panels

You can search for other vessels or various chart items from a chart panel.

Activate the cursor on the panel to search from the cursor position. If the cursor is not active, the system searches for items from the vessel's position.



→ **Note:** You must have a SIRIUS data package subscription to search for fueling stations and an AIS receiver connected to search for vessels.

3D charts

The 3D option provides a three dimensional graphical view of land and sea contours.

→ **Note:** All chart types work in 3D mode, but without 3D cartography for the appropriate area the chart appears flat.

When the 3D chart option is selected, the Pan and the Rotate icons appear on the chart panel.



Panning the 3D chart

You can move the chart in any direction by selecting the Pan icon and then panning in the desired direction.

Press the **X** key or select the **Return to vessel** menu option to stop panning, and to center the chart to vessel position.



Controlling the view angle

You can control the view angle by selecting the Rotate icon and then panning the chart panel.

- To change the direction you are viewing, pan horizontally
- To change the tilt angle of the view, pan vertically

→ **Note:** When centered on the vessel position, only the tilt angle can be adjusted. The view direction is controlled by the chart orientation setting. See "*Positioning the vessel on the chart panel*" on page 26.

Zooming a 3D chart

You zoom in and out on a 3D chart by using the zoom panel icons or the rotary knob.

Chart overlay

Radar, structure, SonarChart Live (Navionics charts only) and weather data can be displayed as overlay on your chart panel.

When an overlay is selected, the chart menu expands to include basic menu functions for the selected overlay.

Radar, structure and weather functions are described in separate sections in this manual. For more information about SonarChart Live, see section "*SonarChart Live*" on page 32.

Insight and C-MAP charts

All possible menu options for Insight and C-MAP charts are described below. The features and menu options available can vary depending on the charts you use. This section shows menus from an Insight chart.

→ **Note:** A menu option is greyed out if it is not available on the chart displayed. For example, raster charts are not available with Insight, so the Raster charts menu option is greyed out when Insight charts are displayed.

Insight and C-MAP tides and currents

The system can display Insight and C-MAP tides and currents. With this information it is possible to predict the time, level, direction and strength of currents and tides. This is an important tool when considering planning and navigation of a trip.

In large zoom ranges the tides and currents are displayed as a square icon including the letter **T** (Tides) or **C** (Current). When you select one of the icons, tidal or current information for that location are displayed.

Dynamic current data can be viewed by zooming inside a 1-nautical mile zoom range. At that range, the Current icon changes to an animated dynamic icon that shows the speed and direction of the current. Dynamic icons are colored in black (greater than 6 knots), red (greater than 2 knots and less than or equal to 6 knots), yellow (greater than 1 knot and less than or equal to 2 knots) or green (equal to or less than 1 knot), depending on the current in that location.

If there is no current (0 knots) this will be shown as a white, square icon.

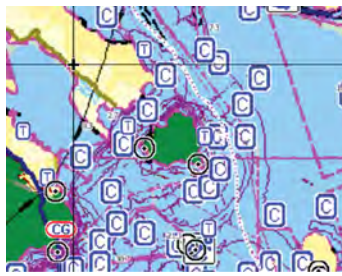

Static Current and Tide icons

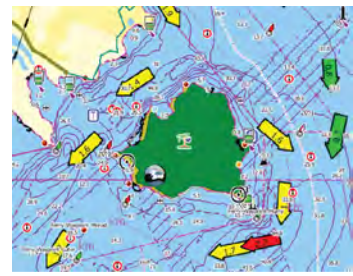

Dynamic Current icons

Insight and C-MAP specific chart options

Orientation, Look ahead, 3D, and change Chart source (previously described in this section) are common for all chart types.



Presentation

The charts can be displayed in different imagery styles.



Shaded relief

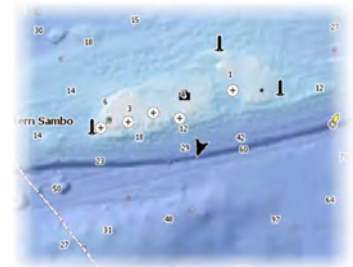

No contours

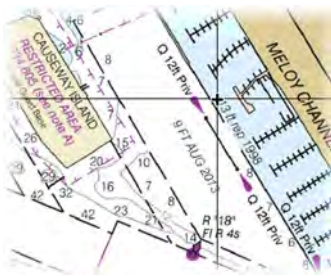

Raster imagery

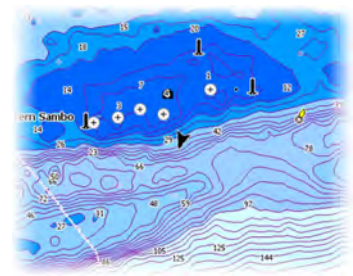

High resolution bathymetry

Shaded relief

Shades seabed terrain.

No contours

Removes contour lines from the chart.

Raster charts

Changes the view to that of a traditional paper chart.

Raster transparency

Controls the transparency of raster imagery.

High resolution bathymetry

Enables and disables higher concentration of contour lines.

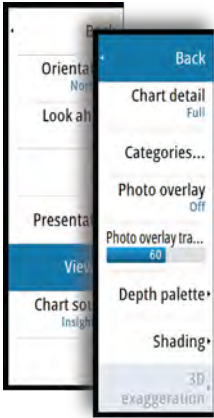

Insight and C-MAP view options

Chart detail

- **Full**
All available information for the chart in use.
- **Medium**
Minimum information sufficient for navigation.
- **Low**
Basic level of information that cannot be removed, and includes information that is required in all geographic areas. It is not intended to be sufficient for safe navigation.

Insight and C-MAP chart categories

Insight and C-MAP charts include several categories and sub-categories that you can turn on/off individually depending on which information you want to see.

Photo overlay

Photo overlay enables you to view satellite photo images of an area as an overlay on the chart. The availability of such photos is limited to certain regions, and cartography versions. You can view photo overlays in either 2D or 3D modes.



No Photo overlay



Photo overlay, land only



Full Photo overlay

Photo transparency

The Photo transparency sets the opaqueness of the photo overlay. With minimum transparency settings the chart details are almost hidden by the photo.



Minimum transparency



Transparency at 80



Depth palette

Controls the Depth palette used on the map.

Paper chart

Changes the appearance of the map to a paper chart style.

Safety depth

Insight and C-MAP charts use different shades of blue to distinguish between shallow (lighter shades) and deep (darker shades) water. After enabling Safety depth, specify the desired safety depth limit. The Safety depth sets the limit at which depths will be drawn without blue shading.

Depth filter

Filters out depth values shallower than the selected depth filter limit.

Shading

Shades different areas of the seabed, depending on the selected Shading category.

→ **Note:** Composition and Vegetation shading are not applicable to C-MAP charts.

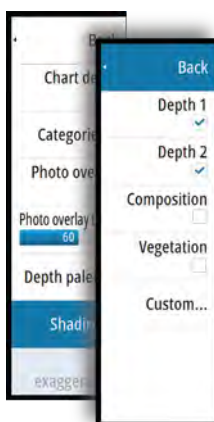

Depth 1 and Depth 2

Depth presets that shade different depths in different colors.

Custom

You can adjust the depth threshold, color and opacity (transparency) of color shading for Depth 1 and Depth 2.

3D exaggeration

Graphical settings that are available in 3D mode only. Exaggeration is a multiplier applied to the drawn height of hills on land, and troughs in water to make them look taller or deeper.

→ **Note:** This option is grayed out if the data is not available in the map card inserted.

Navionics charts

Some Navionics features require the most current data from Navionics. For those features, a message is displayed stating that the feature is unavailable if you do not have the appropriate Navionics charts or chart card inserted. For more information on what is required for these features, refer to www.navionics.com

Navionics specific chart options

Orientation, Look ahead, 3D and change Chart source (previously described in this section) are common for all chart types.

Community edits

Toggles on the chart layer including Navionics edits. These are user information or edits uploaded to Navionics Community by users, and made available in Navionics charts.

For more information, refer to Navionics information included with your chart, or to Navionics website: www.navionics.com.

SonarChart Live

SonarChart Live is a real-time feature where the device creates an overlay of depth contours based on your own live sonar soundings.

In the Navionics chart menu, select **Overlay** and then **SonarChart Live** to display it as an overlay on the chart.

When you select SonarChart Live overlay the menu expands to display SonarChart Live Options. Use the options to set the transparency and minimum depth.

Transparency

The SonarChart Live overlay is drawn on top of other chart data. The chart data is completely covered at minimum transparency. Adjust the transparency to allow the chart details to be seen.

Minimum depth

Adjusts what SonarChart Live rendering treats as the safety depth. This affects the coloring of the SonarChart Live area. As the vessel approaches the safety depth, the SonarChart Live area will gradually change from a simple grey/white to red.

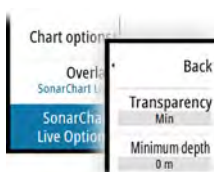
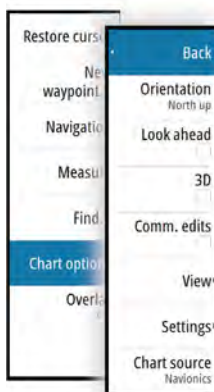



Navionics view options

Chart shading

Shading adds terrain information to the chart.

Navionics dynamic tide and current icons

Shows tides and currents with a gauge and an arrow instead of the diamond icons used for static tides and current information.

The tide and current data available in Navionics charts are related to a specific date and time. The system animates the arrows and/or gauges to show the tides and currents evolution over time.

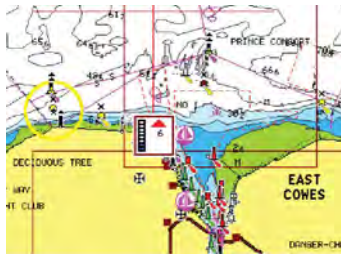

Dynamic tide information



Dynamic current information

The following icons and symbology are used:



Current speed

The arrow length depends on the rate, and the symbol is rotated according to flow direction. Flow rate is shown inside the arrow symbol. The red symbol is used when current speed is increasing, and the blue symbol is used when current speed is decreasing.



Tide height

The gauge has 8 labels and is set according to absolute max/min value of the evaluated day. The red arrow is used when tide is rising, and the blue arrow is used when tide is falling.

→ **Note:** All numeric values are shown in the relevant system units (unit of measurement) set by user.

Easy View

Magnifying feature that increases the size of chart items and text.

→ **Note:** There is no indication on the chart showing that this feature is active.

Photo overlay

Photo overlay enables you to view satellite photo images of an area as an overlay on the chart. The availability of such photos is limited to certain regions, and cartography versions. You can view photo overlays in either 2D or 3D modes.



No Photo overlay

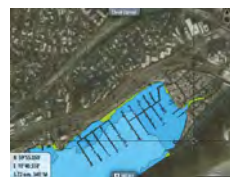

Photo overlay, land only



Full Photo overlay

Photo transparency

The Photo transparency sets the opaqueness of the photo overlay. With minimum transparency settings the chart details are almost hidden by the photo.



Minimum transparency



Maximum transparency

SonarChart

The system supports the Navionics SonarChart feature.

SonarChart displays a bathymetry map showing high resolution contour detail and standard navigational data. For more information, refer to www.navionics.com.

SC Density

Controls the density of the SonarChart and SonarChart Live contours.

Fishing range

Select a range of depths between which Navionics fills with a different color.

This allows you to highlight a specific range of depths for fishing purposes. The range is only as accurate as the underlying chart data, meaning that if the chart only contains 5 meter intervals for contour lines, the shading is rounded to the nearest available contour line.

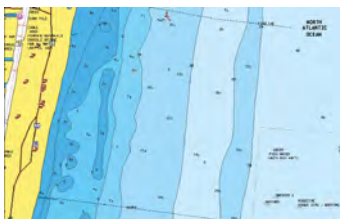

No Depth highlight range

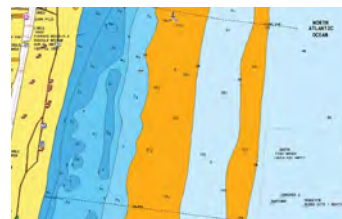

Depth highlight range: 6 m - 12 m

Shallow water highlight

Highlights areas of shallow water.

This allows you to highlight areas of water between 0 and the selected depth (up to 10 meters/30 feet).



No shallow water highlighted



Shallow water highlight: 0 m - 3 m



Navionics chart settings

Colored seabed areas

Used for displaying different depth areas in different shades of blue.

Presentation type

Provides marine charting information such as symbols, colors of the navigation chart and wording for either International or U.S. presentation types.

Annotation

Determines what area information, such as names of locations and notes of areas, is available to display.

Chart details

Provides you with different levels of geographical layer information.

Safety depth

The Navionics charts use different shades of blue to distinguish between shallow and deep water.

Safety depth, based on a selected limit, is drawn without blue shading.

→ **Note:** The built in Navionics database features data down to 20 m, after which it is all white.

Contours depth

Determines which contours you see on the chart down to the selected safety depth value.

Rock filter level

Hides rock identification on the chart beneath a given depth.

This helps you to declutter charts in areas where there are many rocks located at depths well below your vessel's draught.

Chart settings

Settings and display options made in the Chart settings page are common for all chart panels.

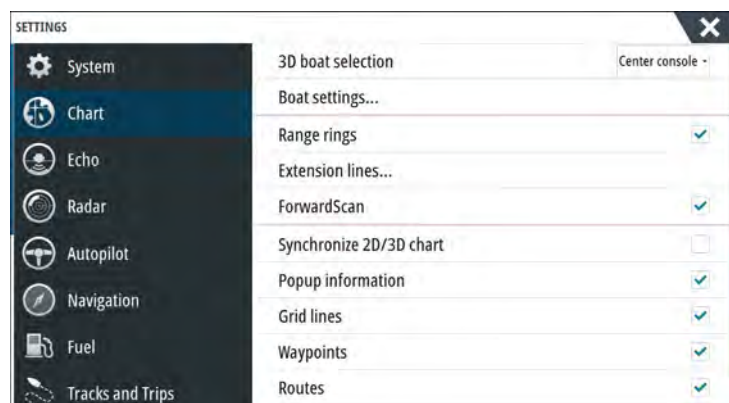

3D boat selection

Determines which icon to use on 3D charts.

Boat settings

The boat settings are used when calculating an automatic route. The boat's draught, width and height must be input to use Navionics Dock-to-dock autorouting and easy routing features.

→ **Note:** Dock-to-doc Autorouting is not available in units used in U.S. territorial waters.

Range Rings

The range rings can be used to present the distance from your vessel to other chart objects. The range scale is set automatically by the system to suit the chart scale.

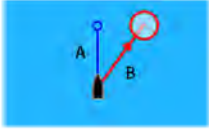

Extension lines

Sets the lengths of the extension lines for your vessel and for other vessels shown as AIS targets.

A: Heading

B: Course Over Ground (COG)

The lengths of the extension lines are either set as a fixed distance, or to indicate the distance the vessel moves in the selected time period. If no options are turned on for the vessel then no extension lines are shown for your vessel.

Your vessel heading is based on information from the active heading sensor and the COG is based on information from the active GPS sensor.

For other vessels, COG data is included in the message received from the AIS system.



ForwardScan

If you have ForwardScan and this option is selected, the ForwardScan heading extension is shown on the chart. Refer to "*Heading extension*" on page 91.

SonarChart Live tide correction

When selected, the tide correction feature uses information from nearby tide stations (if available) to adjust the depth values used by SonarChart Live as the sonar is recorded.

Synchronize 2D/3D chart

Links the position shown on one chart with the position shown on the other chart when a 2D and a 3D chart are shown side by side.

Pop-up information

Selects whether basic information for chart items is displayed when you select the item.

Grid lines

Turns on/off viewing of longitude and latitude grid lines on the chart.

Waypoints, Routes, Tracks

Turns on/off displaying of these items on chart panels. Also opens the Waypoints, Routes and Tracks dialogs you can use to manage them.

5

Waypoints, Routes, and Tracks

Waypoints

A waypoint is a user generated mark positioned on a chart, on a radar image or on the Echosounder image. Each waypoint has an exact position with latitude and longitude coordinates. A waypoint positioned on the Echosounder image has a depth value, in addition to position information. A waypoint is used to mark a position you later may want to return to. Two or more waypoints can also be combined to create a route.

Saving waypoints

A waypoint is saved at the cursor position if active or at the vessel's position if the cursor is not active on the panel, by doing the following:

- Pressing the rotary knob
- Pressing the **Mark** key
- Using the new waypoint option in the menu

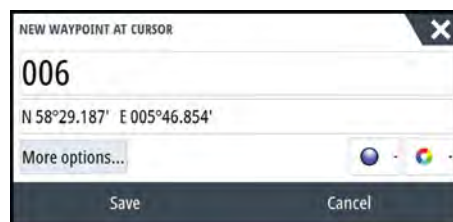

Moving a waypoint

1. Select the waypoint you want to move. The waypoint icon expands to indicate that it is active.
2. Activate the menu and select the waypoint in the menu
3. Select the move option
4. Select the new waypoint position
5. Press the **Enter** key or the rotary knob to confirm the new position.

The waypoint is now automatically saved at the new position.

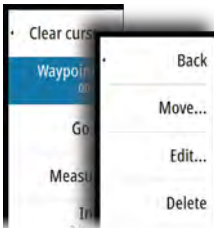

Edit a waypoint

You can edit all information about a waypoint from the **Edit Waypoint** dialog.

This dialog is activated by selecting the waypoint's pop-up, by pressing the rotary knob, or from the menu when the waypoint is activated.

The dialog can also be accessed from the Waypoints tool on the **Home** page.



Waypoint alarm settings

You can set an alarm radius for each individual waypoint you create. The alarm is set in the **Edit Waypoint** dialog.

- **Note:** The waypoint radius alarm must be toggled ON in the alarm dialog to activate an alarm when your vessel comes within the defined radius. For more information, refer to "*Alarms dialog*" on page 118.



Routes

A route consists of a series of routepoints entered in the order that you want to navigate them.

When you select a route on the chart panel it turns green, and the route name is displayed.

The system includes support for Navionics Autorouting and C-MAP Easy Routing. This feature automatically suggests routepoints between the first and last routepoint of a route, or between selected routepoints in a complex route. You can use the feature when you create a new route, or you can use it to edit already saved routes.

Creating a new route on the chart panel

1. Activate the cursor on the chart panel
2. Select the new route option from the menu
3. Position the first waypoint on the chart panel
4. Continue positioning new routepoints on the chart panel until the route is completed
5. Save the route by selecting the save option in the menu.

Edit a route from the chart panel

1. Select the route to make it active
 2. Select the route edit option in the menu
 3. Position the new routepoint on the chart panel:
 - If you set the new routepoint on a leg, a new point is added between existing routepoints
 - If you set the new routepoint outside the route, the new routepoint is added after the last point in the route
 4. Drag a routepoint to move it to a new position
 5. Save the route by selecting the save option in the menu.
- **Note:** The menu changes depending on the selected edit option. All edits are confirmed or cancelled from the menu.

Dock-to-dock Autorouting and Easy Routing

The Dock-to-dock Autorouting and Easy Routing suggest new routepoint positions based on information in the map and on your boat's size. Before you can start using this feature the boat draught, width and height must be entered into the system. The boat settings dialog is automatically displayed if the information is missing when you start the feature.

- **Note:** Units designed for sale in the U.S. region do not have Autorouting capabilities. Autorouting features are disabled on all non-U.S. units when they are used in U.S. territorial waters.
- **Note:** It is not possible to start the Dock-to-dock Autorouting or Easy Routing if one of the selected routepoints is located in an unsafe area. A warning dialog is displayed, and you have to move the relevant routepoint(s) to a safe area to proceed.
- **Note:** If no compatible cartography is available, the Dock-to-dock Autorouting or Easy Routing menu option is not available. Compatible cartography includes C-MAP MAX-N+, Navionics+ and Navionics Platinum. For a full selection of available charts, visit www.gofreemarine.com, www.c-map.com or www.navionics.com.
1. Position at least two routepoints on a new route, or open an existing route for editing.
 2. Select **Dock-to-dock Autorouting**, followed by:
 - **Entire Route** if you want the system to add new routepoints between the first and the last routepoint of the open route.
 - **Selection** if you want to manually select the routepoints that define the limits for the autorouting, then select the relevant routepoints. Selected routepoints are colored red. Only two routepoints can be selected, and the system discards any routepoints between your selected start and end points.
 3. Select **Accept** to start the automatic routing.

- When the automatic routing is completed the route appears in preview mode, and the legs are color coded to indicate safe or unsafe areas. Navionics uses red (unsafe) and green (safe), while C-MAP uses red (unsafe), yellow (dangerous) and green (safe).
- 4. Move any routepoints if required when the route is in preview mode.
- 5. Select **Keep** to accept the routepoints positions.
- 6. Eventually repeat step 2 (**Selection**) and step 3 if you want the system to automatically position routepoints for other parts of the route.
- 7. Select **Save** to complete the automatic routing and save the route.

Dock-to-dock Autorouting and Easy Routing examples

- **Entire route** option used when first and last route points are selected.



First and last routepoint



Result after automatic routing

- **Selection** option used for autorouting part of a route.



Two routepoints selected



Result after automatic routing

Creating routes using existing waypoints

You can create a new route by combining existing waypoints from the **Routes** dialog. The dialog is activated by using the **Waypoints** tool on the **Home** page and then selecting the **Routes** tab.

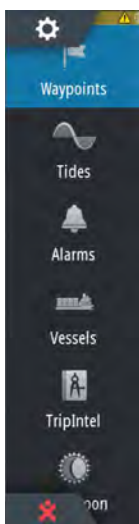

Converting Tracks to Routes

You can convert a track to a route from the Edit Track dialog. The dialog is activated by activating the track, then selecting the track's pop-up, pressing the rotary knob or selecting the info options from the menu.

You can convert a track to a route from the Edit Track dialog. The dialog is activated by activating the track, then selecting the track's pop-up, pressing the rotary knob or selecting the info options from the menu.

The Edit Tracks dialog can also be accessed by selecting the Tracks tool on the **Home** page.



The Edit Route dialog

You can add and remove routepoints from the **Edit Route** dialog. This dialog is activated by selecting an active route's pop-up, by pressing the rotary knob, or from the menu. The dialog can also be accessed by using the **Waypoints** tool on the **Home** page.



Tracks

Tracks are a graphical presentation of the historical path of the vessel, allowing you to retrace where you have travelled. Tracks can be converted to routes from the **Edit** dialog.

From the factory, the system is set to automatically track and draw the vessel's movement on the chart panel. The system continues to record the Tracks until the length reaches the maximum points, and then automatically begins overwriting the oldest points.

The automatic tracking function can be turned off from the Tracks dialog.

Creating new Tracks

You can start a new track from the Tracks dialog, activated by using the **Waypoints** tool on the **Home** page.

Tracks settings

Tracks are made up of a series of points connected by line segments whose length depends on the frequency of the recording.

→ **Note:** The Tracks option must also be turned ON in the chart settings to be visible.

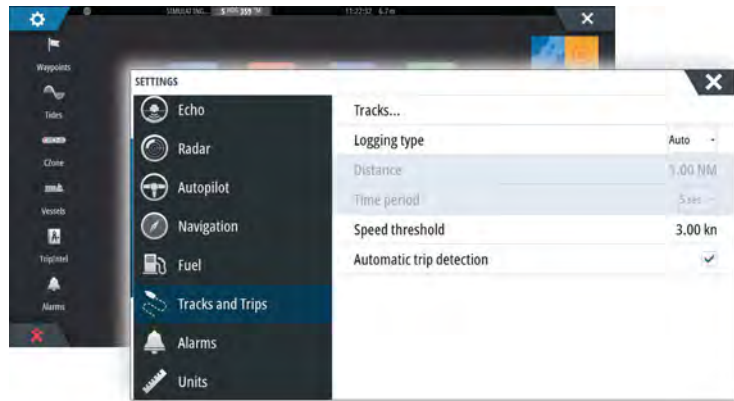

Waypoints, Routes, and Tracks dialogs

The Waypoints, Routes, and Tracks dialogs give access to advanced edit functions and settings for these items.

The dialogs are accessed by selecting the **Waypoints** button on the **Tools panel** on the **Home** page.

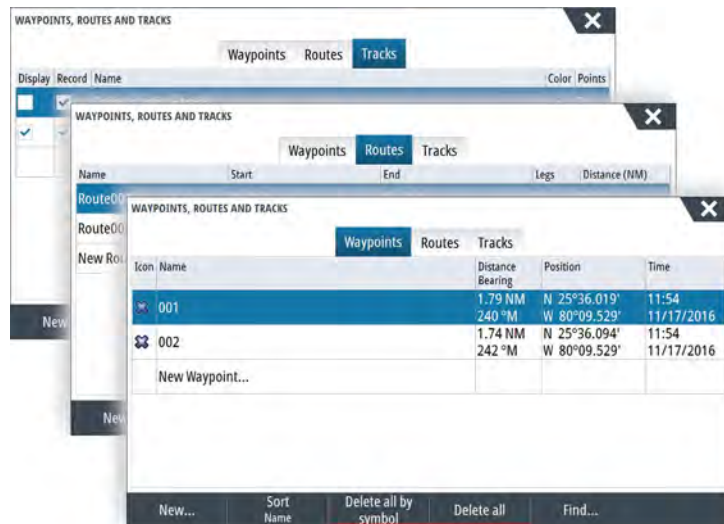

6

Navigating

The navigation function included in the system allows you to navigate to the cursor position, to a waypoint, or along a predefined route.

If autopilot functionality is included in your system, the autopilot can be set to automatically navigate the vessel.

For information about positioning waypoints and creating routes, refer to "*Waypoints, Routes, and Tracks*" on page 37.

Navigation panels

The Nav and Position panels can be used to display information when you are navigating.

The Nav panel

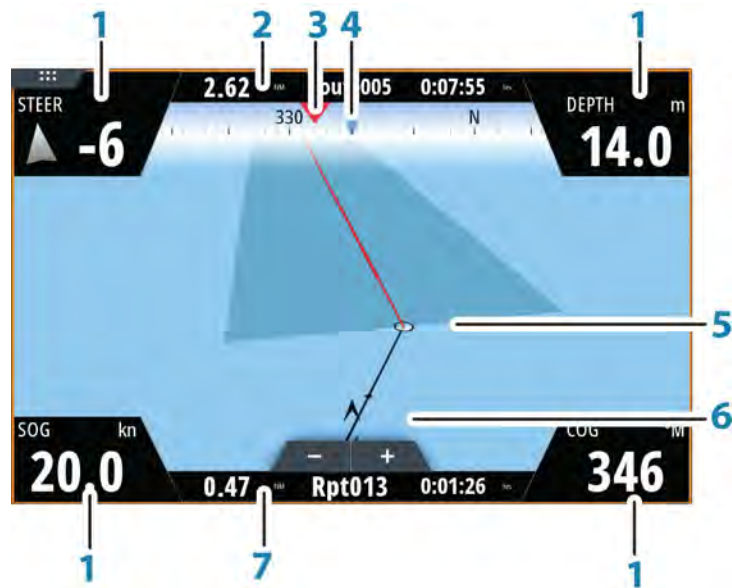

The Nav panel is activated from the Home page, either as a full page panel or as part of a multiple panel page.

- 1 Data fields**
- 2 Route information**
- 3 Vessel heading**
- 4 Bearing to next routepoint**
- 5 Bearing line with allowed off course limit**
When travelling on a route the bearing line shows the intended course from one waypoint towards the next. When navigating towards a waypoint (cursor position, MOB or an entered lat/lon position), the bearing line shows the intended course from the point at which navigation was started towards the waypoint.
- 6 Vessel symbol**
Indicates distance and bearing relative to the intended course. If the XTE (Cross Track Error) exceeds the defined XTE limit, this is indicated with a red arrow including the distance from the track line. Refer to "*XTE limit*" on page 45.
- 7 Routepoint information**

Position panels

You can switch between displaying the Nav panel or the Position panel. The Position panel is activated from the menu.

By default, there is one position panel available showing GPS position.

If Loran is enabled, there are two position panels. This is indicated with arrow symbols on left and right side of the panel.

You toggle between the panels by selecting the left or right arrow symbols, or by using the arrow keys.



GPS position info



Loran position info

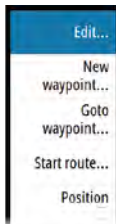

Edit data fields

To change the data fields displayed on the Navigation panels:

1. Activate the menu
2. Select the edit option from the menu
3. Activate the field you want to edit
4. Select the information type
5. Save your changes.

Navigate to cursor position

You can start navigating to a cursor position on any chart, radar, or Echosounder panel. Position the cursor at the selected destination on the panel, and then select the **Goto Cursor** option in the menu.

→ **Note:** The **Goto Cursor** menu option is not available if you are already navigating.

Navigate a route

You can start navigating a route from the chart panel or from the **Route** dialog.

When route navigation is started, the menu expands and shows options for canceling the navigation, for skipping a waypoint, and for restarting the route from current vessel position.

Starting a route from the chart panel

Activate a route on the panel, and then select the route navigation option from the menu.

You can select a routepoint to start navigating from a selected position.

Start navigating a route from the Route dialog

You can start navigating from the **Route** dialog, activated by:

- Selecting the **Waypoint** tool from the **Home** page and then the **Routes** tab
- Selecting the route details from the menu

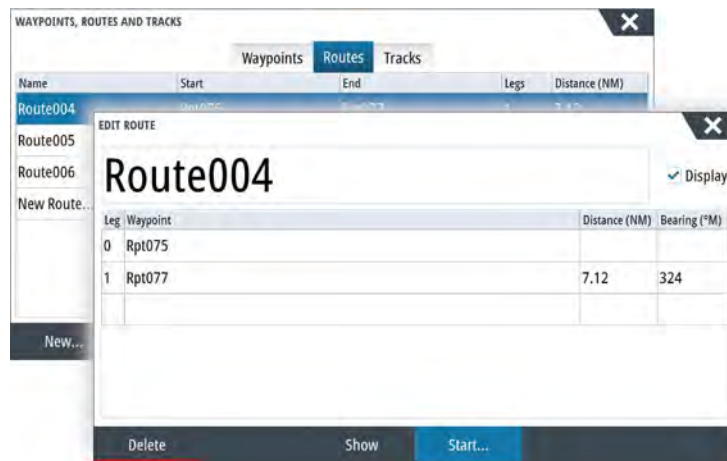

Cancel navigation

When you are navigating, the menu includes an option for cancelling the navigation.



Navigating with the autopilot

When you start navigation on a system with autopilot functionality, you are prompted to set the autopilot to navigation mode.

→ **Note:** The prompt to set the autopilot to navigation mode is disabled if the boat type is set to SAIL in the Autopilot Commissioning dialog.

If you choose not to engage the autopilot or if your boat is set to SAIL, the autopilot can be set to navigation mode from the Autopilot Controller later on. For more information about autopilot functionality, refer to "Autopilot" on page 50.

Navigation settings

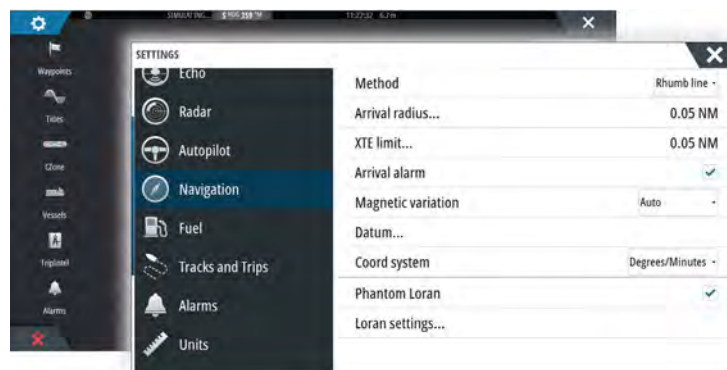

Navigation method

Different methods are available for calculating the distance and bearing between any two points on a chart.

The Great circle route is the shortest path between two points. However, if you are to travel along such a route, it would be difficult to steer manually as the heading would constantly be changing (except in the case of due north, south, or along the equator).

Rhumb lines are tracks of constant bearing. It is possible to travel between two locations using Rhumb line computation, but the distance would usually be greater than if Great circle is used.

Arrival radius

Sets an invisible circle around the destination waypoint.

The vessel is considered arrived at the waypoint when it is within this radius.

XTE limit

This setting defines how far the vessel can deviate from the selected route, if the vessel goes beyond this limit, an alarm is activated.

Arrival alarm

When the arrival alarm is enabled, an alarm is activated when the vessel reaches the waypoint or when it is within the specified arrival radius.

Magnetic variation

Magnetic variation is the difference between true bearings and magnetic bearings, caused by different locations of the Geographic and the Magnetic north poles. Any local anomalies such as iron deposits might also affect the magnetic bearings.

When set to Auto, the system automatically converts magnetic north to true north. Select manual mode if you need to enter your own local magnetic variation.

Datum

Most paper charts are made in the WGS84 format, which also is used by the NSS evo3.

If your paper charts are in a different format, you can change the datum settings accordingly to match your paper charts.

Coordinate system

Several coordinate systems can be used to control the format for latitude and longitude coordinates displayed on the chart panel.

Phantom Loran

Enables use of Phantom Loran positioning system.

Loran settings

Defines Loran chains (GRI) and preferred station for waypoint entry, cursor position and position panel.

The graphic example shows a cursor position window with Loran position information. For more information refer to your Loran system documentation.

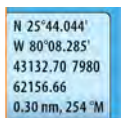

7

TripIntel

TripIntel lets you store and recall information on trips. You can use the information to make informed decisions prior to commencing a trip, or when a trip is underway.

- **Note:** Vessel Fuel setup is required for this feature. Refer to the unit's separate installation manual.
- **Note:** For best results, it is recommended to run software version 2.4.0 or newer in your EP-85R Storage Device or latest software in your Fuel Data manager.

Select the TripIntel button on the Tool panel to display the TripIntel page.

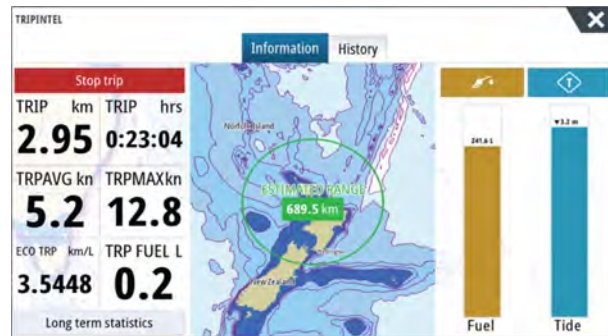
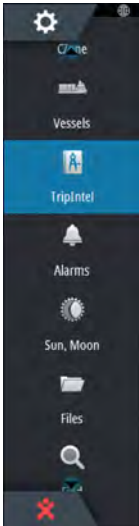

Current trip statistics

The Information tab on the TripIntel page shows current trip statistics:

- Distance traveled
- Time traveled
- Average speed
- Maximum speed
- Fuel economy
- Fuel used

Automatic trip recording

There is an automatic trip detection feature. When you start navigating you are prompted to start recording the trip if no trip is currently underway and your speed has been more than 2 knots for 20 seconds. You will be prompted to continue a trip or start a new trip if the trip was not explicitly saved before a power off.

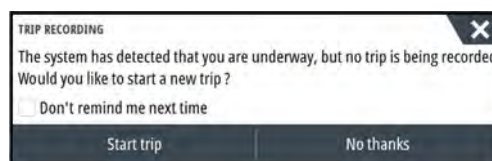

You can manually start the recording later from the TripIntel page.

You can turn off the automatic trip detection feature from the Tracks and Trip settings dialog.

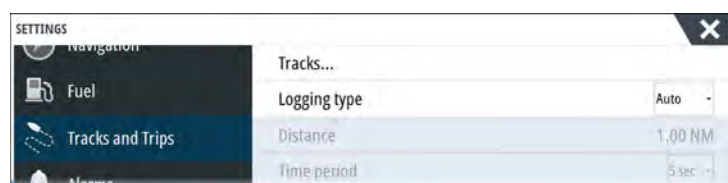

Start and stop trip recordings

If you have selected to not start recording a trip from the automatic trip detection prompt, you can manually start a recording from the Triptel page.

The **Start** and **Stop** trip options let you specify a trip recording. You can use them to segment a single passage into multiple trips providing a finer level of control of the information that is logged for a journey.

Long-term statistics

Select Long Term Statistics to view seasonal trip information such as engine running hours, total distance traveled, and fuel economy.

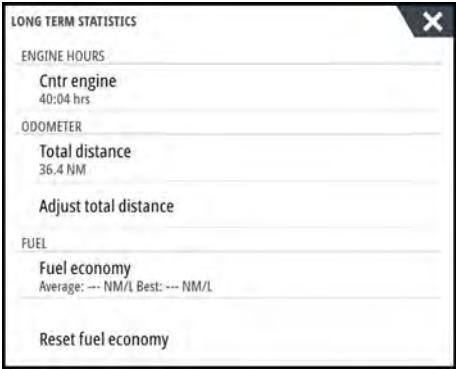

Adjust total distance

Select the Adjust total distance button to change the Total distance. Use this option if you have not recorded a trip or part of a trip that you have taken and want to include the distance in the Total distance statistic.

Reset fuel economy

Select **Reset fuel economy** to reset the fuel economy in the Fuel economy gauge on the Instrument bar.

Estimated fuel range ring

The Estimated fuel range ring on the Triptel page represents the estimated total distance that the boat can travel based on historical consumption, and the amount of fuel left in the tanks.

- **Note:** The Estimated fuel range ring represents fuel consumption on a one way trip only, it does not include fuel estimates for the return trip to your current location. It represents the distance in which your boat will completely run out of fuel.
- **Note:** The Estimated fuel range ring is calculated from the Vessel Fuel Remaining only, not level sensors. When recording your refueling, you must 'Set to full' or 'Add fuel' for the range ring to be accurate.

Fuel gauge

The Fuel Gauge on the Triptel page, and on the economy gauge is displayed based on the setting in the Vessel Setup page. You must select the Fuel Remaining measurement type.

- Fuel consumed by engine(s)
- Fuel tank level sensor(s)

→ **Note:** This is only for the Triptel page and the economy graph.



Record your refueling

Select the Fuel button to record the amount of your refuel. The refuel information is used for calculating the Vessel Fuel Remaining amount.

Tide gauge

The Tide gauge on the TripIntel page shows the tide height at the selected tide station.

Tide graphs and stations

Tide stations on Chart cards provide tide information. Select the Tide button to view tide graphs and specify which Tide station provides tide information. If no tide station is chosen, tide information from the nearest tide station is used.

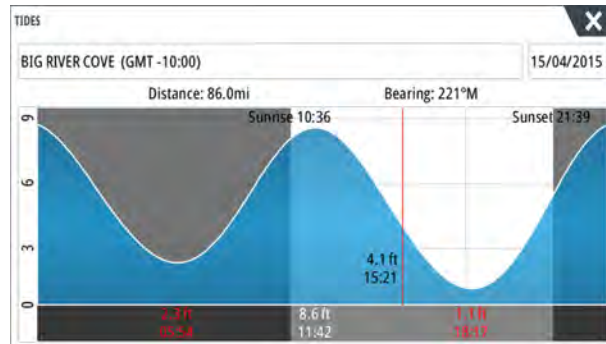

View trip recordings

Recorded trips are listed in the History tab on the TripIntel page. To view detailed trip information select a trip in the list.

The screenshot shows the "TRIPINTEL" interface with the "History" tab selected. Under "Today's activity", there is a "TRIP HISTORY" table with the following data:

Trip Name	Time	Distance (NM)
Trip 1	14m 37s	4.39 NM
Ladies Bay-Karaka B	11m 10s	3.62 NM
Tibbs Beach-Coxs Bay	45m 10s	14.10 NM
Whites Bay-Sandy Bay	37m 45s	11.37 NM
Sandy Bay-Little Bay	17m 13s	5.03 NM
View Bay- Shelly Bay	1h 14m	20.00 NM

Change trip recording names

Trips are given generic names when they are created. You can change the trip name to a more meaningful one by selecting it on the History list and then select the name in the Trip History details dialog. This opens the Trip name dialog where you can change the trip name.

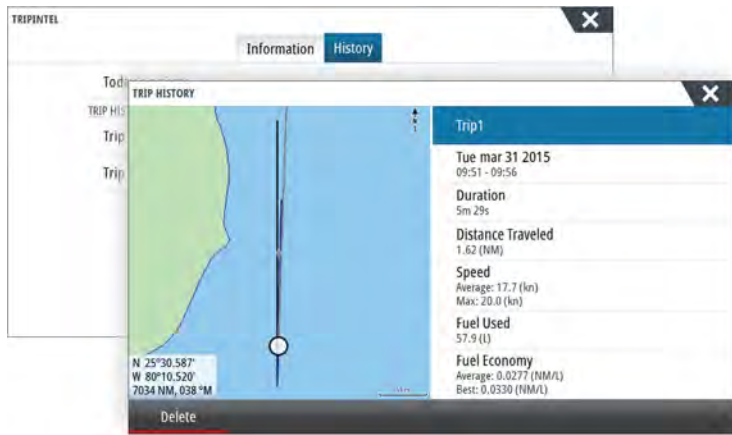

8

Autopilot

If a compatible autopilot computer is connected to the system, autopilot functionality is available in the system.

The system does not allow for more than one autopilot computer on the network.

The display unit automatically detects the autopilot computer available on the network and presents settings, configuration and user options for the connected computer.

For details about installing and configuring an autopilot computer, refer to the separate manuals that come with the autopilot computer.

Safe operation with the autopilot

⚠ Warning: An autopilot is a useful navigational aid, but DOES NOT replace a human navigator.

Activating the autopilot

You activate the autopilot from any panel by selecting the autopilot tile in the Instrument bar, followed by selecting a mode in the **Autopilot Controller**.

Switching from automatic mode to manual steering

You switch the autopilot to STBY mode from any automatic operation mode from the autopilot pop-up or using a physical standby key.



Autopilot indication on the pages



- 1 Autopilot indication in Status bar
- 2 Autopilot pop-up
- 3 Autopilot tile in Instrument bar

Autopilot mode indication in the Status bar

The Status bar shows autopilot information as long as an autopilot computer is connected to the network.

Icons are included if the autopilot is passive or locked by another autopilot control unit.

Autopilot pop up

You control the autopilot from the autopilot pop-up.

The pop-up has a fixed position on the page, and it is available for all pages except when an Autopilot panel is active.



As long as the autopilot pop-up is active, you cannot operate the background panel or its menu.

You remove the pop-up from a page by selecting the **X** in the upper right corner, or by pressing the **X** key. You turn it on again by selecting the autopilot tile in the instrument bar.

The following pop-ups are available:

- **Autopilot controller**, showing active mode, heading, rudder and various steering information depending on active autopilot mode. Manual adjustments to the set heading can only be made when the port and starboard arrow indicators are illuminated red and green.
 - **Mode selection**, includes access to turn pattern selection.
 - **Turn pattern selection**
- **Note:** The turn steering option is not available if the boat type is set to SAIL in the Autopilot Commissioning dialog, instead the tack/gybe feature is implemented. Refer to "Tacking in AUTO mode" on page 52 and "Tacking in WIND mode" on page 55.



Autopilot controller



Mode selection



Turn pattern selection

Autopilot tile in Instrument bar

You can select to show the autopilot tile in the Instrument bar.

If the autopilot pop-up is turned off you can turn it on by selecting the tile in the Instrument bar.



The Autopilot panel

The autopilot panel is used to display navigation data. It can be shown as a full screen panel, or in a multi-panel page.

The number of data fields included in the autopilot panel is dependent on available panel size.



Data fields

The following abbreviations are used in the autopilot panel:

CTS	Course to steer
DTD	Distance to destination
DTW	Distance to next waypoint
SOG	Speed over ground
COG	Course over ground
XTE	Cross track error (L: left or R: right)

Autopilot modes

The autopilot has several steering modes. The number of modes and features within the mode depend on the autopilot computer, the boat type and available inputs, as explained in the description of the following steering modes.

Standby mode

Standby mode is used when you steer the boat at the helm. Switch the autopilot to Standby mode from any operation by selecting the **Standby** mode button in the autopilot pop-up or using a physical standby key.

Non-Follow Up (NFU, Power steering)

In NFU mode you use the port and starboard arrow buttons in the autopilot pop-up to control the rudder. The rudder will move as long as the button is pressed.

- Activate NFU mode by selecting the port or starboard arrow button in the pop-up when the autopilot is in Standby or FU mode.

You return to Standby mode by selecting the **Standby** mode button in the autopilot pop-up or using a physical standby key.

Follow-up steering (FU)

In FU mode you use the rotary knob to control the rudder angle. Press the rotary knob, then turn the knob to set the rudder angle. The rudder moves to the commanded angle and then stop.

- You select FU mode from the autopilot pop-up
- **Note:** If the autopilot pop-up is closed or if an alarm dialog is activated on the unit controlling the autopilot in FU mode, the autopilot automatically changes to Standby mode.

⚠ Warning: While in FU mode you cannot take manual control of the wheel.

AUTO mode (auto compass)

In AUTO mode the autopilot issues rudder commands required to steer the vessel automatically on a set heading.

- You select AUTO mode from the autopilot pop-up. When the mode is activated, the autopilot selects the current boat heading as the set heading.

Changing set heading in AUTO mode

You adjust the set heading by using the rotary knob, the Port/Starboard arrow buttons in the autopilot pop-up, or by selecting the Heading tile in the autopilot pop-up and then entering the desired heading value.

An immediate heading change takes place. The new heading is maintained until a new heading is set.

Heading capture

When the vessel is turning in AUTO mode, an instant reset of the mode activates the heading capture function. This automatically cancels the turn, and the vessel continues on the heading read from the compass the very moment you re-activated the mode.

Tacking in AUTO mode

- **Note:** The tack function is only available when the system is set up for boat type SAIL in the Autopilot Commissioning dialog and is not available for NAC-1 autopilot computers.



Tacking should only be performed into the wind and must be tried out in calm sea conditions with light wind to find out how it works on your boat. Due to a wide range of boat characteristics (from cruising to racing boats) the performance of the tack function may vary from boat to boat.

Tacking in AUTO mode is different from tacking in WIND mode. In AUTO mode the tack angle is fixed and as defined by the user. For more details, refer to *"Tacking in WIND mode"* on page 55.

You initiate the tack function from AUTO mode.

When tacking direction is selected the autopilot changes the current set course according to the set fixed tacking angle.

You can interrupt the tack operation as long as the tack dialog is open by selecting the opposite tacking direction. When interrupted the boat returns to the previous set heading.

NoDrift mode

NoDrift mode combines the autopilot and the positioning information from the GPS.

In NoDrift mode the vessel is steered along a calculated track line in a direction set by the user. If the vessel's heading is drifting away from the original heading due to current and/or wind, the vessel follows the line with a crab angle.

1. Turn the vessel to the desired heading
2. Activate the NoDrift mode. The autopilot draws an invisible bearing line based on current heading from the boat's position

Unlike in AUTO (compass) mode, the autopilot now uses the position information to calculate the cross track error, and automatically keeps your track straight.

You use the port/starboard arrow panel buttons in the autopilot pop-up or the rotary knob to reset the bearing line while in NoDrift mode.

Dodging

If you need to avoid an obstacle when using NoDrift mode, you can set the autopilot to Standby mode and power steer or use the helm until the obstacle is passed.

If you return to NoDrift mode within 60 seconds you can select to continue on previous set bearing line.

If you do not respond, the dialog disappears and the autopilot goes to NoDrift mode with current heading as set bearing line.

NAV mode

⚠ Warning: NAV mode should only be used in open waters.

You can use the autopilot to automatically steer the boat to a specific waypoint location, or along a pre-defined route. The position information from the GPS is used to change the course to steer to keep the boat on the track line and to the destination waypoint.

→ **Note:** To obtain satisfactory navigation steering, the NSS evo3 must have valid position input. Autosteering must be tested and determined satisfactory prior to entering the NAV mode.

Start automatic navigating

When you start navigating a route or to a waypoint from the chart panel, you are prompted to set the autopilot to NAV mode. If you reject this request, you can start NAV mode from the Autopilot controller.

→ **Note:** The prompt to set the autopilot to navigation mode is disabled if the boat type is set to SAIL in the Autopilot Commissioning dialog. To start navigating, you must select NAV mode from the Autopilot controller.

When NAV mode is initiated, the autopilot automatically keeps the vessel on the leg.

When the vessel reaches the arrival circle for a routepoint, the autopilot gives an audible warning and displays a dialog with the new course information. If the required course change to the next waypoint is less than the Navigation change limit, the autopilot automatically changes the course. If the required course change to next waypoint in a route

is more than the set limit, you are prompted to verify that the upcoming course change is acceptable.

→ **Note:** For information about navigation settings, refer to "Navigation settings" on page 44.

Waypoint arrival circle

The Arrival radius defines the point at which a turn is initiated when you are navigating a route.

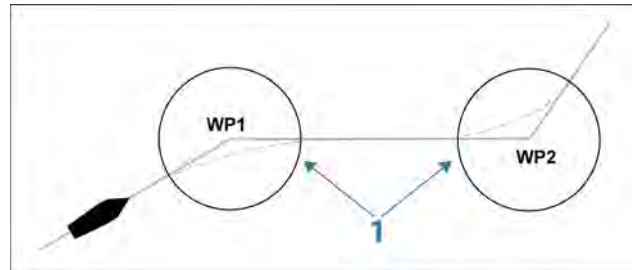

The arrival circle (1) should be adjusted according to boat speed. The higher the speed, the wider the circle. The intention is to make the autopilot start the heading change in due time to make a smooth turn onto the next leg.

The figure below may be used to select the appropriate waypoint circle when creating the route.

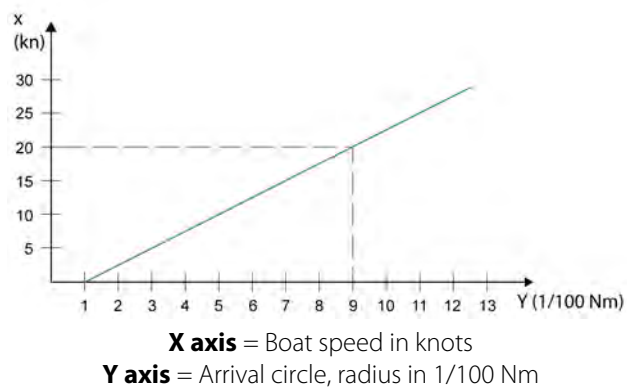

Example: With the speed of 20 knots you should use a waypoint circle with radius 0.09 Nm.

→ **Note:** The distance between any waypoints in a route must not be smaller than the radius of the waypoint arrival circle.

WIND mode

→ **Note:** The WIND mode is only available if the system has been set up for sailboat in the Autopilot Commissioning dialog. This mode is not available for NAC-1 autopilot computers.

Before the WIND mode is started it must be verified that valid input from wind transducer is available.

Initiate wind steering as follows;

1. Switch the Autopilot to AUTO mode
2. Adjust the boat heading until wind angle is according to the angle you want to maintain
3. Select the mode indication in the autopilot controller to activate the autopilot menu, and select WIND mode

The set course to steer (CTS) and set wind angle are entered from the compass heading and the wind transducer at the moment the WIND mode is selected. From that point the autopilot changes the course to maintain the wind angle as the wind direction may change.

Tacking in WIND mode

→ **Note:** The tack function is only available when the system is set up for boat type SAIL in the Autopilot Commissioning dialog and is not available for NAC-1 autopilot computers

Tacking should only be performed into the wind and must be tried out in calm sea conditions with light wind to find out how it works on your boat. Due to a wide range of boat characteristics (from cruising to racing boats) the performance of the tack function may vary from boat to boat.

Tacking in WIND mode as compared to AUTO mode is performed when sailing with apparent or true wind as the reference. The true wind angle should be less than 90 degrees. The rate of turn during the tack will be given by the Tack time defined in the sailing parameter setup. The tack time is also controlled by the speed of the boat to prevent loss of speed during a tack.

You can initiate the tack function from WIND mode.

When you initiate the tacking, the autopilot immediately mirrors the set wind angle to the opposite side of the bow.

You can interrupt the tack operation as long as the tack dialog is open by selecting the opposite tacking direction. When interrupted, the boat returns to the previous set heading.

Gybing

Gybing is possible when the true wind angle is larger than 120°.

The time to make a gybe is determined by the speed of the boat to make it as quick as possible within control.

Turn pattern steering

The autopilot includes a number of automatic turn steering features when the autopilot is in AUTO mode.

→ **Note:** The turn steering option is not available if the boat type is set to SAIL in the Autopilot Commissioning dialog, instead the tack/gybe feature is implemented.



Initiating a turn

You start the turn by selecting the relevant turn icon, followed by selecting the port or starboard options in the turn dialog to select the turn direction.

Stopping the turn

You can stop the turn from within the turn dialog.

At any time during a turn you can select **Autopilot standby** in the System Controls dialog to return to Standby mode and manual steering.

You can also stop a turn by pressing a physical standby key to return to Standby mode and manual steering.

Turn variables

The turn steering options, except the C-turn, have settings that you can adjust before you start a turn and at any time when the boat is in a turn.

U-turn

U-Turn changes the current set heading to be 180° in the opposite direction.

The turn rate is identical to Rate limit settings. This cannot be changed during the turn.

→ **Note:** Refer to the separate NSS evo3 Installation manual for information about Rate limit settings.

C-turn

Steers the vessel in a circle.

You can adjust the Rate of turn from the turn dialog before the turn is initiated and during the turn. Increasing the turn rate makes the vessel turn a smaller circle.

Spiral turn

Spiral-turn makes the vessel turn in a spiral with a decreasing or increasing radius. You set the initial radius before the turn is initiated, and the change per turn during the turn. If the change per turn is set to zero, the vessel turns in a circle. Negative values indicate decreasing radius while positive values indicate increasing radius.

Zigzag turns

Steers the vessel in a zigzag pattern.

For navigating in a zigzag pattern, you set the initial heading change before the turn is started.

During the turn you can alter the main heading, the heading change, and the leg distance.

Square turn

Makes the vessel automatically turn 90° after having travelled a defined leg distance.

At any time during the turn you can change the main heading and the distance of the leg until the vessel makes a new 90° turn.

Lazy S-turn

Makes the vessel yaw around the main heading.

You set the selected heading change before the turn is started.

During the turn you can alter the main heading, the heading change and the turn radius from within the turn dialog.

Depth contour tracking, DCT™

If the system has Echosounder input, the autopilot can be set to follow a depth contour.

⚠ Warning: Do not use this feature unless the seabed is suitable. Do not use it in rocky waters where the depth is varying significantly over a small area.

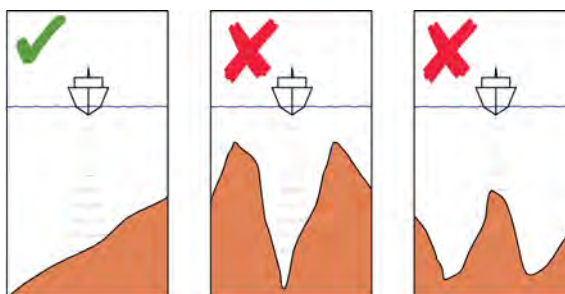

Use the following process to initiate DCT steering:

1. Ensure that you have depth reading on the panel or on a separate depth instrument.
2. Steer the boat to the depth you want to track, and in the direction of the depth contour.
3. Activate **AUTO** mode, select depth contour steering and monitor the depth reading.
4. Select the port or starboard option in the turn dialog to initiate the depth contour steering to follow the bottom sloping to starboard or to port:

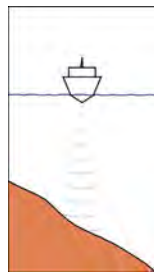

*Port option
(depth decreases to port)*

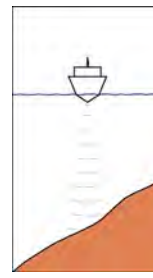

*Starboard option
(depth decreases to starboard)*

The following parameters are available for depth contour tracking:

Depth gain

This parameter determines the ratio between commanded rudder and the deviation from the selected depth contour. The higher depth gain value the more rudder is applied.

If the value is too small, it takes a long time to compensate for drifting off the set depth contour, and the autopilot fails to keep the boat on the selected depth.

If the value is set too high, the overshoot increases and the steering is unstable.

Contour Cross Angle (CCA)

The CCA is an angle that is added to or subtracted from the set course.

With this parameter you can make the boat yaw around the reference depth with lazy-s movements.

The larger the CCA, the bigger yawing is allowed. If you the CCA set to zero there are no lazy-s movements.

Using the NSS evo3 in an AP24/AP28 system

Command transfer

If your NSS evo3 is connected to an autopilot system including an AP24 or AP28 control unit, only one control unit can be active at the same time. An inactive control unit is indicated with a square with a cross symbol in autopilot controller pop-up.



Locking remote stations

The AP24/AP28 includes a Remote Lock function that disables autopilot control from other units. A locked control unit is indicated with a key symbol in autopilot controller pop-up.

When the remote lock function is enabled on an AP24/AP28 control unit, only the active control unit stays in command. No transfer of command to NSS evo3 or other autopilot control units on the system can take place.

You can only unlock the remote stations from the AP24/AP28 unit in command.



Using the autopilot in an EVC system

When the NSS evo3 is connected to an EVC system via the SG05, you can take manual control of the steering regardless of the autopilot mode.

The mode indicator on the pilot pop-up is replaced by a dash to indicate EVC override.

The system returns to NSS evo3 control in standby mode if no rudder command is given from the EVC system within a predefined period.



Using the NSS evo3 in an AP70/AP80 system

If your MFD is connected to an AP70/AP80 autopilot system, the MFD can be used to operate the autopilot.

In an AP70/AP80 autopilot system, only one control unit can be active at the same time.

→ **Note:** The MFD cannot be used to configure or commission an AP70/AP80 system.



The thruster symbol on the MFD Mode button indicates thrusters are defined in the AP70/AP80 autopilot system.

For more information about AP70/AP80 autopilot system, refer to the separate AP70/AP80 documentation.

Autopilot detection

The AP70/AP80 system has its own source groups. For compatibility reasons if the MFD is going to be used to run the AP70/AP80 system, the MFD must use the same source groups as the AP70/AP80 system.

When a MFD is connected to an AP70/AP80 system, it detects the AP70/AP80 system and a prompt is displayed asking if the MFD should restart and use the AP70/AP80 system source groups (restart in professional autopilot compatibility mode).

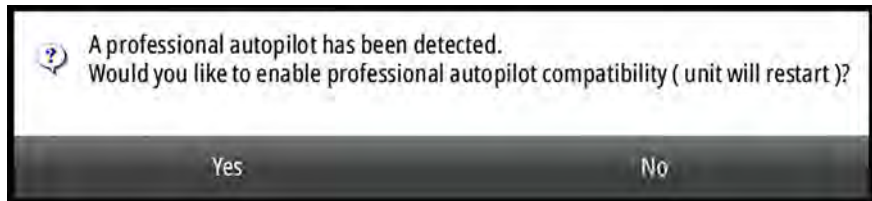

If yes is selected, then the MFD restarts using the same source groups as the AP70/AP80 system. If No is selected then the question is not asked again and the MFD cannot be used to operate the AP70/AP80 system.

This setting can be changed by selecting Professional autopilot compatibility in the Advanced settings dialog.

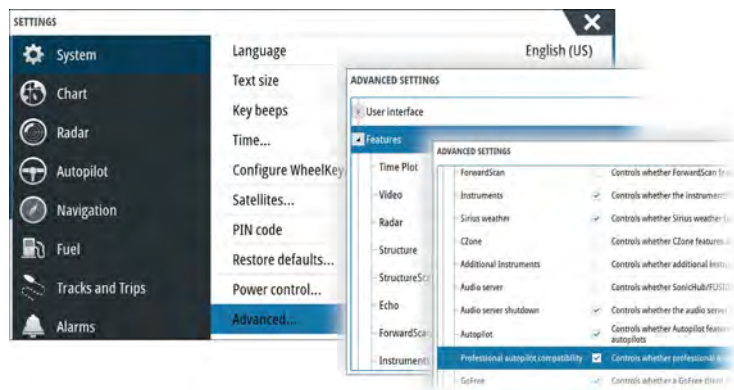

Running thruster symbols

When thrusters are running in an AP70/AP80 system, thruster symbols are displayed in the MFD Autopilot controller pop-up.



	Clockwise thrust rotation.
	Counter-clockwise thrust rotation.

Command transfer

An AP70/AP80 system can be set up as a Master system or an Open system.





In a Master setup, the master controller gives control to other control units. An MFD cannot be the master controller in a Master setup. In a Master setup, the MFD can request to control the autopilot and the MFD must accept control from the master controller after the master controller approves transfer of control to the MFD. Once control is accepted, the MFD is active and can be used to operate the autopilot.

In an Open system setup, the MFD can take control of the autopilot by selecting the Mode button on the Autopilot controller pop-up and then selecting **Take cmd** in the CMD transfer

dialog. When this occurs the MFD becomes active and the other control units become passive.

In an Open system, control stations can be temporarily locked to avoid accidental control from another control unit. When the MFD has control in an Open system, the MFD can lock and unlock all passive control units. If the MFD is passive and locked, it can request control of the autopilot from the active control unit. The MFD must accept control from the active controller after the active controller approves transfer of control to the MFD.

The following indicators are displayed in the Mode button of the Autopilot controller pop-up:

	<p>Passive - MFD does not have control of the autopilot. If only the passive icon is displayed, it means it is an Open unlocked system and selecting the Mode button takes control of the autopilot.</p>
	<p>Locked system - The key icon indicates it can be a Master system or a locked Open system. If the key icon is displayed, and the <10, <1, 10>, 1> buttons are enabled (red or green colored arrows and white numbers) then the MFD is active and controls the autopilot.</p>  <p>If the key icon is displayed, and the <10, <1, 10>, 1> buttons are disabled (black arrows and numbers) then the MFD is passive and does not control the autopilot. Select the Mode button to request control from the active control unit if it is a locked Open system, or the master controller if it is a Master system.</p> 
<p>none</p>	<p>Active in Open system - the MFD has control of the autopilot in an Open system.</p>

Locking and un-locking other control units

Select the Cmd/Thruster option in the Mode selection pop-up to open the Cmd/Thruster selection pop-up.

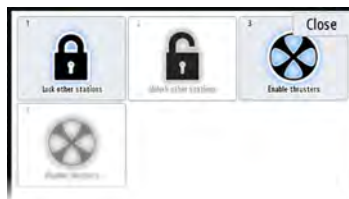

Unlock other stations - allows other control units to take control of the autopilot without requesting permission.

Lock other stations - locks other control units from taking control of the autopilot. When other control units are locked, they must request control of the autopilot from the MFD. When control of the autopilot is requested from another control unit, a prompt is displayed in the MFD to authorize command transfer.



Selecting the work profile

The AP70/AP80 can be set up with 6 different work profiles associated with different work modes or preferences. Use the AP70/AP80 controller to set up the different work profiles. In the MFD, the active work profile is displayed in the Mode button of the MFD Autopilot controller pop-up and the Mode selection pop-up. If the MFD has control of the autopilot, you can use it to select which work profile is active.

To change the work profile using the MFD, the autopilot must be in standby mode.

1. Select the Mode button in the Autopilot controller pop-up to display the Mode selection pop-up
2. Select the Work profiles button to display defined work profiles in the Work profiles selection pop-up

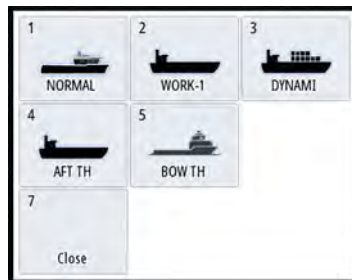

3. Select the work profile you want to activate
4. Select Close to close the Work profiles selection pop-up.

Enabling and disabling thrusters

Select the Cmd/Thrusters button in the Modes selection pop-up to open the Cmd/Thrusters selection pop-up.

The Cmd/Thrusters selection pop-up provides options to enable or disable thrusters.

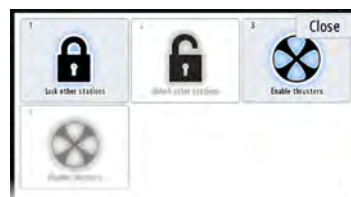

Autopilot settings

The autopilot settings can be split between settings done by the user, and settings done during installation and commissioning of the autopilot system.

- User settings can be changed for various operational conditions or user preferences
- Installation settings are defined during commissioning of the autopilot system. No changes should later be done to these settings

Both user settings and installation settings depends on which autopilot computer that is connected to the system.

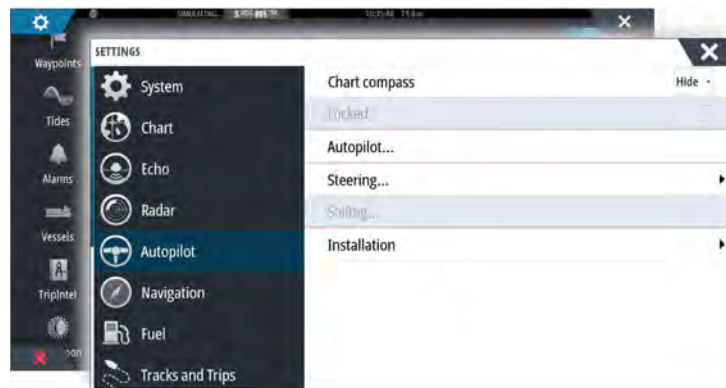

The following sections describe the settings that can be changed by the user. The settings are described per autopilot computer.

Installation settings are available in the documentation following the autopilot computers.

Chart compass

You can select to show a compass symbol around your boat on the chart panel. The compass symbol is off when the cursor is active on the panel.

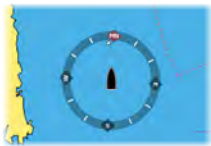

Locking autopilot operation from a unit

You can lock a unit to prevent unauthorized operation of the autopilot. When the unit is locked, it is indicated with a lock symbol and with text in the pop up. No automatic modes can be selected from a locked display.

→ **Note:** The lock function is not available on a unit which has autopilot control!

If the NSS evo3 is part of an AP24/AP28 system, all other autopilot control units can be locked for autopilot control from the AP24/ AP28 control unit.

NAC-2/NAC-3 Autopilot computer

Steering (NAC-2/NAC-3)

These options allow for manually changing parameters that were set during the commissioning of the autopilot computer. For more details, refer to the separate documentation for the autopilot computer.

- Turn rate: Preferred turn rate used while turning in degrees per minute
- Rudder gain: This parameter determines the ratio between commanded rudder and the heading error. The higher rudder value the more rudder is applied. If the value is too small it will take a long time to compensate for a heading error, and the autopilot will fail to keep a steady course. If the value is set too high the overshoot will increase and the steering will be unstable.
- Counter rudder: Relation between change in heading error and applied rudder. Higher counter rudder will reduce applied rudder faster when approaching the set heading
- Autotrim: Controls how aggressively the autopilot will apply rudder to compensate for a constant heading offset, e.g. when external forces such as wind or current affects the heading. Lower autotrim will give faster elimination of a constant heading offset
- **Note:** In VRF mode this parameter controls the time constant of the rudder estimate. A lower value makes the rudder estimate faster, i.e. that it will more quickly catch up with the boat's movements.
- Init rudder: Defines how the system moves the rudder when switching from manual steering to an automatic mode.
 - Center: Moves the rudder to zero position
 - Actual: Maintains the rudder offset
- Rudder limit: Determines the maximum rudder movement in degrees from midship position that the autopilot can command the rudder in the automatic modes. The Rudder

limit setting is only active during autosteering on straight courses, NOT during course changes. Rudder limit does not affect Non-Follow-up steering

- Off heading limit: Sets the limit for the off heading alarm. An alarm occurs when the actual heading deviates from the set heading more than the selected limit
- Track response: Defines how fast the autopilot shall respond after having registered a cross track distance
- Track approach angle: Defines the angle used when the vessel is approaching a leg. This setting is used both when you start navigating and when you use track offset
- Course change confirm angle: Defines the limits for course change to next waypoint in a route. If the course change is more than this set limit, you are prompted to verify that the upcoming course change is acceptable.

Sailing (NAC-2/NAC-3)

→ **Note:** Sailing parameters are only available when the boat type is set to Sail.

- Wind mode: Select what wind function the autopilot will use when in wind mode
 - Auto:
 - If TWA is $<70^\circ$: Wind mode will use AWA
 - If TWA is $\geq 70^\circ$: Wind mode will use TWA
 - Apparent
 - True
- Tack time: Controls the rate of turn (tack time) when performing a tack in wind mode.
- Tack angle: Controls the angle that the boat will tack to between 50° - 150° in AUTO mode
- Manual speed: If neither boat speed or SOG data is available and or deemed reliable a manual value for speed source can be entered and used by the autopilot to aid steering calculations

Steering response

→ **Note:** Only available for NAC-1 autopilot computers.

Used to increase or decrease the steering sensitivity. A low response level reduces the rudder activity and provides a more *loose* steering. A high response level increases the rudder activity and provides more *tight* steering. Too high a response level will cause the boat to make **S** movements.

Installation

Used for autopilot installation and commissioning. See the separate NSS evo3 Installation manual.

Commissioning

→ **Note:** Only available for NAC-1 autopilot computers.

Used for commissioning the rudder or virtual rudder feedback. See the separate NSS evo3 Installation manual.

9

Radar

The radar panel can be set up as a full screen view or combined with other panels.

The radar image can also be displayed as an overlay on a chart panel. For more information, see "Chart overlay" on page 29.

→ **Note:** Radar overlay requires data from a heading sensor or compass to ensure proper orientation with the chart.

The radar panel

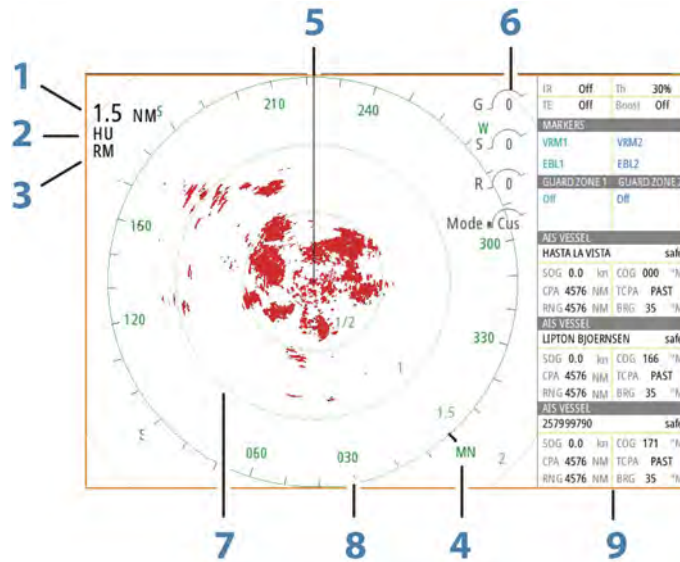

- 1 Range
- 2 Orientation
- 3 Motion
- 4 Compass*
- 5 Heading line*
- 6 Rotary controls
- 7 Range rings*
- 8 Range markers*
- 9 Data bar

* Optional radar symbology.

Radar symbology can be turned ON/OFF collectively from the Radar menu, or individually as described in "Radar settings panel" on page 73.

Dual radar

You can connect to any combination of two supported radars and see both radar images at the same time.

→ **Note:** Interference will be seen on the Broadband Radar on most ranges when a pulse or Halo radar, and a Broadband radar are transmitting at the same time on the same boat. We recommend to only transmit on one radar at a time. For example, transmit Broadband radar for typical navigational usage, or pulse or Halo radar to locate weather cells, defined coastlines at a distance and to trigger Racons.

You can select a dual radar panel by pressing and holding the Radar application button on the **Home** page, or by creating a favorite page with two radar panels.

Selecting the radar source

You specify the radar in the Radar panel by selecting one of the available radars in the radar source menu option. If you have a multiple Radar panel, the radar is set individually for each radar panel. Activate one of the radar panels, and then select one of the available radars in the radar source menu option. Repeat the process for the second radar panel, and select an alternative radar for this panel.

→ **Note:** The 3-digit radar source number is the last 3 digits of the radar's serial number.

Radar overlay

You can overlay the Radar image on the Chart. This can help you to easily interpret the radar targets by correlating the radar targets with charted objects.

→ **Note:** A heading sensor must be present in the system for radar overlay.

When the radar overlay is selected, basic radar operational functions are available from the Chart panel's menu.

Selecting radar overlay source on chart panels

To select the radar source of the radar overlay displayed on the chart panel, use the **Radar options** and then **Source** chart panel menu options to select the radar source.

For chart pages with more than one chart with radar overlay, it is possible to set up different radars sources for each chart panel. Activate one of the chart panels and then select one of the available radars in the radar source menu option. Repeat the process for the second chart panel with radar overlay, and select an alternative radar for this panel.

Radar operational modes

The radar's operational modes are controlled from the Radar menu. The following modes are available:

Power off

The power to the radar scanner is turned off. **Power off** is only available when radar is in standby mode.

Standby

The power to the radar scanner is on, but the radar is not transmitting.

→ **Note:** You can also put the radar in standby mode from the **System Controls** dialog.

Halo light

Controls the levels of the Halo Radar pedestal blue accent lighting. There are four levels possible for the lighting. The accent lighting can only be adjusted when the radar is in standby mode.

→ **Note:** The blue accent pedestal lighting might not be approved for use in your boating location. Check your local boating regulations before turning the blue accent lights ON.

Transmit

The scanner is on and transmitting. Detected targets are drawn on the radar PPI (Plan Position Indicator).

→ **Note:** You can also put the radar in transmit mode from the **System Controls** dialog.

Radar Range

You adjust radar range by turning the rotary knob or by selecting the zoom icons on the radar panel.



Dual range

(Broadband 4G and Halo Radar only)

When connected to a Broadband 4G or Halo radar, it is possible to run the radar in Dual Range mode.

The radar appears in the radar sources menu as two virtual radar sources A and B. Range and radar controls for each virtual radar source are fully independent and the source can be selected for a particular chart or radar panel in the same manner as dual radar described in "Selecting the radar source" on page 64.

→ **Note:** Some controls that are related to physical properties of the radar itself are not independent of source. These are Fast Scan, Antenna Height and Bearing alignment.

MARPA is fully independent and up to 10 targets may be tracked for each virtual radar source.

Up to two independent Guard Zones may also be defined for each virtual radar source.

Using the cursor on a radar panel

By default, the cursor is not shown on a radar panel.

When you position the cursor on the radar panel, the cursor position window is activated and the cursor menu options are displayed.

To remove the cursor and cursor elements from the panel, select **Clear cursor** or press the **X** key.

GoTo cursor

You can navigate to a selected position on the image by positioning the cursor on the panel, then using the **Goto Cursor** option in the menu.

The cursor assist function

→ **Note:** The cursor assist function is available if it is enabled. Refer to "Customizing the long press feature" on page 19.

The cursor assist function allows for fine tuning and precision placement of the cursor without covering details with your finger.

Activate the cursor on the panel, then press and hold your finger on the screen to switch the cursor symbol to a selection circle, appearing above your finger.

Without removing your finger from the screen, drag the selection circle to the desired position.

When you remove your finger from the screen the cursor reverts to normal cursor operation.

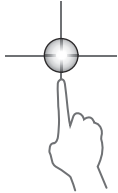

Saving waypoints

A waypoint is saved at the cursor position if active or at the vessel's position if the cursor is not active on the panel, by doing the following:

- Pressing the rotary knob
- Pressing the **Mark** key
- Using the new waypoint option in the menu



Radar sector blanking

(Halo Radar only)

You can define up to four sectors on the PPI inside which no radar data is transmitted. This enables you to blank-out interference caused by features on your boat or from a secondary radar. The blanking occurs on the main radar image and radar overlay on a chart. An enabled sector is shown as a magenta outline with 3 arcs crossing the blanking area. To specify radar sector blanking, refer to the Halo Radar Installation Manual.

→ **Note:** Radar sector blanking is only available for Halo radars.



Main radar PPI



Radar overlay on a chart

Adjusting the radar image

You may be able to improve the radar image by adjusting the radar sensitivity, and by filtering out the random echoes from sea and weather conditions.

The radar control images are located in the upper right corner of the radar panel. You can adjust the image settings by selecting the radar control image or by pressing the rotary knob. The selected control expands and displays its name in full and a slide bar is displayed. You can then adjust the value by turning the rotary knob or by using the slide bar.

You can also adjust the image settings from the radar menu.

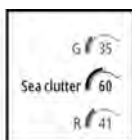

Radar use modes

(Halo Radar only)

Radar modes are available with default optimal control settings for different environments. The following modes are available:

- **Custom** - In this mode all radar controls can be adjusted and will be retained after a mode change or radar power cycle. Radar defaults are set for general purpose use.
- **Harbor** - In this mode the radar settings are optimized for areas such as busy waterways and large man-made structures where good target discrimination and rapid image updates are needed.
- **Offshore** - In this mode the radar settings are optimized for offshore sea conditions and making isolated targets larger and easy to see.
- **Weather** - In this mode the radar settings are optimized for best detection and presentation of rain clutter. Image update rate is slowed and color depth is increased.
- **Bird** - In this mode the radar settings are optimized for best detection of birds. The radar is set up for maximum sensitivity. This mode is not recommended for use in congested harbor environments.

Not all controls are adjustable in each mode. The following list shows preset controls and adjustability for each control.

Range

Custom: Adjustable
Harbor: Full*
Offshore: Full*
Weather: Full*
Bird: Up to 24nm

Threshold

Custom: Adjustable
Harbor: 30%
Offshore: 30%
Weather: 0%
Bird: 0%

Gain

Custom: Adjustable
 Harbor: Adjustable
 Offshore: Adjustable
 Weather: Adjustable
 Bird: Adjustable

Sea

Custom: Adjustable
 Harbor: Adjustable
 Offshore: Adjustable
 Weather: Adjustable
 Bird: Adjustable

Rain

Custom: Adjustable
 Harbor: Adjustable
 Offshore: Adjustable
 Weather: Adjustable
 Bird: Adjustable

Noise Rejection

Custom: Adjustable
 Harbor: Medium
 Offshore: High
 Weather: Medium
 Bird: High

Target Expansion

Custom: Adjustable
 Harbor: Low
 Offshore: Medium
 Weather: OFF
 Bird: OFF

Interference Reject

Custom: Adjustable
 Harbor: Adjustable
 Offshore: Adjustable
 Weather: Adjustable
 Bird: Adjustable

Target Separation

Custom: Adjustable
 Harbor: Medium
 Offshore: OFF
 Weather: OFF
 Bird: OFF

Fast scan

Custom: Adjustable
 Harbor: High
 Offshore: High
 Weather: OFF
 Bird: OFF

* Maximum range is dependent on antenna length.

Modes in dual ranges

(Halo Radar only)

Modes can be set independently for each range. For example, you can have Offshore mode for range A and Weather mode for range B. However, interaction between ranges occurs in some cases:

- When using Bird mode for both ranges, maximum range is restricted to 24 NM and range resolution is reduced.
- Fast scan - The antenna rotation speed is set to the slower of the two modes selected. For example, Fast Scan is disabled when using Harbor and Weather modes because Fast Scan is Off in Weather mode.
- The Interference reject setting can affect the interference seen or removed on both ranges.

Directional clutter rejection

(Broadband 4G Radar only)

This mode automatically works when GAIN = AUTO and SEA = HARBOR or OFFSHORE. The purpose is to allow smaller vessels to be seen in the leeward direction of the sea clutter. The GAIN of the radar receiver is increased dynamically during the sweep, in the leeward direction, for increased target sensitivity in heavier sea states.

When GAIN or SEA = MANUAL, the Directional Clutter Rejection mode will be OFF (non-directional).

In addition, CALM, MODERATE or ROUGH STC Curve settings are available in the Radar options menu to better optimize the radar image to your liking.

Gain

The gain controls the sensitivity of the radar receiver.

A higher gain makes the radar more sensitive to radar returns, allowing it to display weaker targets. If the gain is set too high, the image might be cluttered with background noise.

Gain has a manual and an automatic mode. You toggle between automatic and manual mode in the slide bar, or by pressing and holding the rotary knob.

Sea clutter

Sea clutter is used to filter the effect of random echo returns from waves or rough water near the vessel.

When you increase Sea clutter, filtering the on-screen clutter caused by the echoes of waves is reduced.

The system includes predefined Sea clutter settings for harbor and offshore conditions for all radar systems except Halo, in addition to the manual mode where you can adjust the settings. For all radar systems except Halo, you select Sea clutter modes from the menu, or by a long press on the rotary knob. You can only adjust the Sea clutter value in manual mode.

Auto Sea Offset

(Halo Radar only)

To allow fine tuning of the Sea control while in Auto mode (Auto uses directional adaptive clutter rejection), the Auto setting may be offset.

Rain clutter

Rain clutter is used to reduce the effect of rain, snow or other weather conditions on the radar image.

The value should not be increased too much as this may filter out real targets.

Advanced radar options

Noise Rejection

(Broadband 4G and Halo radar only)

The Noise Rejection control sets the amount of noise filtering applied by the radar. Target sensitivity is increased at longer ranges when this control is set to Low or High, but does cause some loss of target discrimination.

Tip: To get maximum range performance from Broadband 4G Radar, transmit on one range only, set the Noise Reject control to High and the threshold as low as possible. The default is 30% for less clutter on the screen. If OFF is selected for the NSS evo3, the range performance is about equal to 3G radar. In some areas where extreme high interference may exist, try OFF for best radar image.

Radar threshold

The threshold sets required signal strength for the lowest radar signals. Radar returns below this limit are filtered and are not displayed.

Default value: 30%.

Target expansion

Target expansion increases the length of targets in range, making them easier to see.

Rejecting radar interference

Interference could be caused by radar signals from other radar units operating in the same frequency band.

A high setting reduces the interference from other radars.

In order not to miss weak targets, the interference rejection should be set to low when no interference exists.

Target separation

(Broadband 4G and Halo Radar only)

The **Target separation** control allows you to control the target discrimination of the radar (separation between objects is more prominent).

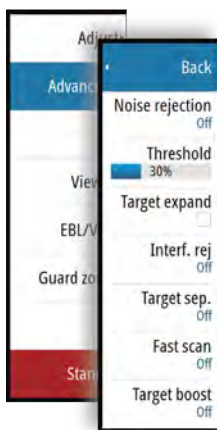

Fast scan

(Broadband and Halo radar only).

Sets the speed of the radar antenna rotation. This option gives faster target updates.

→ **Note:** Maximum speed may not be achieved depending on the radar Settings, Mode, and Range selected. The radar will only rotate as fast as the current control settings allow.

Sea State

Set the Sea State control according to current sea conditions for best sea clutter rejection.

Target boost

(3G and 4G Broadband, and Pulse Radar only)

The target boost control increases pulse length or reduces radar bandwidth to make targets appear larger in range and increase radar sensitivity.

Radar view options

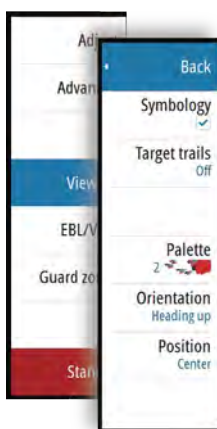

Radar symbology

Radar symbology defined in the Radar Settings panel can be turned on/off collectively. See the radar panel illustration showing optional radar items.

Target trails

You can set how long the trails generated from each target on your radar panel remain. You can also turn OFF target trails.

→ **Note:** True motion is recommended when using Target trails

Clearing target trails from the panel

When target trails are displayed on the panel, the radar menu expands to include an option where you can clear target trails from your radar panel temporarily. The target trails start to appear again unless you switch them off as described above.

The radar palette

Different colors (palettes) can be used to represent detail on your radar panel.

Radar orientation

Radar orientation is indicated on the upper left corner of the radar panel as either HU (Heading UP), NU (North Up) or CU (Course up).

Heading up

Rotates the radar image to display the current heading directly up on the radar image.

North up

Rotates the radar image with the north direction upwards.

Course up

Rotates the radar image to display the current navigation course directly up.

This option works only when the system is navigating an active route. If you are not navigating an active route, the heading up orientation is used until the navigation function is started.

Positioning the radar center

You can move the radar PPI (Plan Position Indicator) center to different positions within the radar panel, and select how your vessel symbol moves on the radar image.

Radar motion is indicated on the upper left corner of the radar panel as either TM (True motion) or RM (Relative motion).

The radar position can only be changed when the radar is transmitting.

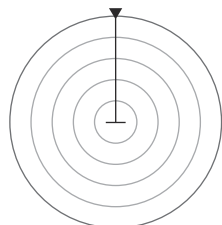

Center

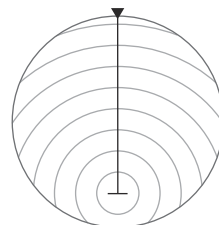

Look ahead

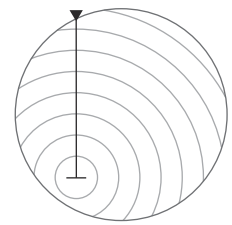

Custom offset

Center

Default setting. The radar PPI center is centered on the radar panel.

Look Ahead

Moves the radar PPI center to the bottom of the panel to maximize the view ahead.

Offset

Allows you to move the PPI center to any location on the radar panel.

1. Select the offset option from the menu
2. Move the cursor to where you want to position the radar center
3. Confirm the setting by selecting the **Save offset** button in the bottom right corner of the panel.

True motion

In True motion, your vessel and moving targets move across the Radar screen as you travel. All stationary objects remain in a fixed position. When the vessel's symbol reaches the edge of the screen, the radar image is redrawn with the vessel symbol repositioned in the center of the screen.

When True motion is selected, the menu expands to include a reset true motion option. This allows for manually resetting the radar image and vessel symbol to the center of the screen.

EBL/VRM markers

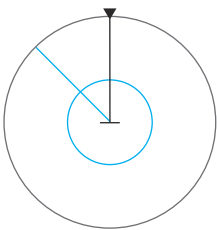

The electronic bearing line (EBL) and variable range marker (VRM) allows quick measurements of range and bearing to vessels and landmasses within radar range. Two different EBL/VRMs can be placed on the radar image.

The EBL/VRMs are by default positioned from the center of the vessel. It is, however, possible to offset the reference point to any selected position on the radar image.

When positioned, you can turn the EBL/VRM on/off by selecting the relevant markers on the data bar, or by deselecting the marker from the menu.

Defining an EBL/VRM marker

1. Ensure that the cursor is not active
2. Activate the menu, select **EBL/VRM**, then select **EBL/VRM 1** or **EBL/VRM 2**
 - The EBL/VRM is now positioned on the radar image
3. Select the adjustment option from the menu if you need to reposition the marker, then adjust the marker by dragging it into position on the radar image
4. Select the save option to save your settings

Placing EBL/VRM markers by using the cursor

1. Position the cursor on the radar image
2. Activate the menu
3. Select one of the EBL/VRM markers
 - The EBL line and the VRM circle are positioned according to the cursor position.

Offsetting an EBL/VRM marker

1. Ensure that the cursor is not active
2. Activate the menu, select **EBL/VRM**, then select the marker you wish to offset
3. Select the set offset option
4. Position the cursor on the radar panel to set the offset position

5. Select the save option to save your settings.

You can reset the EBL/VRM center to vessel position from the menu.

Setting a guard zone around your vessel

A guard zone is an area (either circular or a sector) that you can define on the radar image. When activated, an alarm alerts you when a radar target enters or exits the zone.

Defining a guard zone

1. Ensure that the cursor is not active
2. Activate the menu, select **Guard zones**, then select one of the guard zones
3. Select the shape for the zone
 - The adjustment options depend on the guard zone shape
4. Select **Adjust** to define the settings for the guard zone. The values can be set from the menu or by dragging on the radar panel.
 - **A**: Bearing, relative to the vessel heading
 - **B**: Depth
 - **C**: Range, relative to vessel center
 - **D**: Width
5. Select the save option to save your settings.

When positioned, you can turn the guard zones on/off by selecting the relevant section on the data bar.

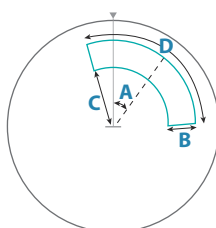

Shape: Sector

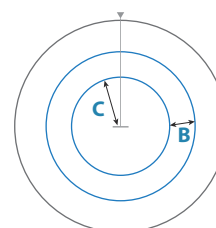

Shape: Circle

Alarm settings

An alarm is activated when a radar target breaches the guard zone limits. You can select if the alarm is activated when the target enters or exits the zone.

Sensitivity

The guard zone sensitivity can be adjusted to eliminate alarms for small targets.

MARPA targets

If the system includes a heading sensor, the MARPA function (Mini Automatic Radar Plotting Aid) can be used to track up to ten radar targets.

You can set alarms to notify you if a target gets too close. Refer to *"Radar settings"* on page 73.



MARPA tracking is an important tool for collision avoidance.

→ **Note:** MARPA requires heading data for both the radar and the NSS evo3.

MARPA target symbols

The system uses the target symbols shown below.

	Acquiring MARPA target. Typically it takes up to 10 full rotations of the scanner.
	Tracking MARPA target, not moving or at anchor.
	Tracking and safe MARPA target with extension lines.

	Dangerous MARPA target. A target is defined as dangerous when it enters the guard zone defined on the radar panel.
	When no signals have been received within a time limit a target will be defined as lost. The target symbol represents the last valid position of the target before the reception of data was lost.
	Selected MARPA target, activated by positioning the cursor on the target icon. The target returns to the default target symbol when the cursor is removed.

Tracking MARPA targets

1. Position the cursor on the target on the radar image
2. Select **Acquire targets** from the menu
3. Repeat the process if you want to track more targets

After your targets are identified, it may take up to 10 radar sweeps to acquire and then track the target.

Cancelling MARPA target tracking

When targets are being tracked, the radar menu expands to include options for cancelling individual targets or to stop the tracking function.

Cancel tracking individual targets by selecting the target icon before activating the menu.

Viewing MARPA target information

If the pop-up is activated, you can select a MARPA target to display basic target information. Information for the 3 MARPA targets closest to the vessel is also displayed in the data bar.

When a target is selected, detailed information for the target can be displayed from the menu.

You can display information about all MARPA targets by using the **Vessels** option on the Home page.

MARPA alarm settings

You can define the following MARPA alarms:

- **MARPA target lost**
Controls whether an alarm is activated when a MARPA target is lost.
- **MARPA unavailable**
Controls whether an alarm is activated if you do not have the required inputs for MARPA to work (valid GPS position and heading sensor connected to the radar server).

Recording radar data

You can record radar data and save the file internally in the NSS evo3 unit, or save it onto a memory card inserted into the unit's card reader.

A recorded radar file can be used for documenting an event or an operational error. A logged radar file can also be used by the simulator.

If more than one radar is available, you can select which source you want to record.

Radar settings

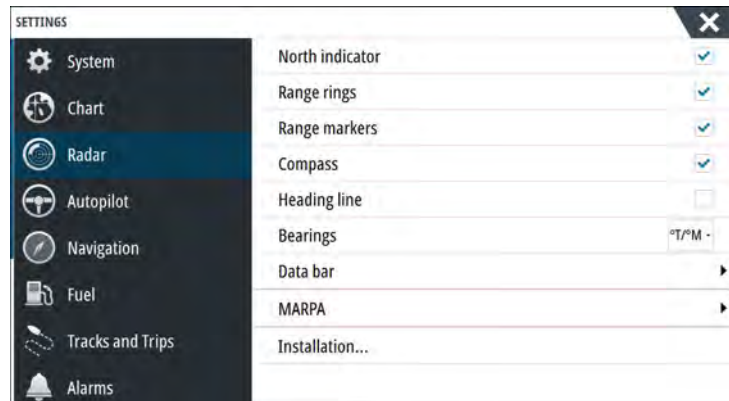

Radar symbology

You can select which optional radar items that should be turned on/off collectively from the menu. Refer to the Radar panel illustration.

Bearings

Used for selecting whether the radar bearing should be measured in relation to True/Magnetic North (°T/°M) or to your relative heading (°R).

Data bar

Turns on/off the radar data bar. Refer to the radar panel illustration.

The data bar can show up to 3 targets, arranged with the most dangerous targets on top. You can select to show MARPA targets on top and before any AIS targets, even if the AIS targets are closer to your vessel.

MARPA settings

You can define the length of the MARPA trail making it easier to follow target movement. A circle can be added around your vessel to present the danger zone. The radius of the ring is the same as the closest point of approach as set in the Dangerous Vessels dialog. Refer to *"Defining dangerous vessels"* on page 102. An alarm triggers if a vessel is tracking into your safe zone.

Installation

The Installation option is used for radar installation, described in the separate Radar or NSS evo3 Installation manuals.

10

Echosounder

The Echosounder function provides a view of the water and bottom beneath your vessel, allowing you to detect fish and examine the structure of the sea floor.

The unit has internal CHRIP, Broadband, StructureScan, TotalScan, and ForwardScan Echosounder.

The Echosounder image

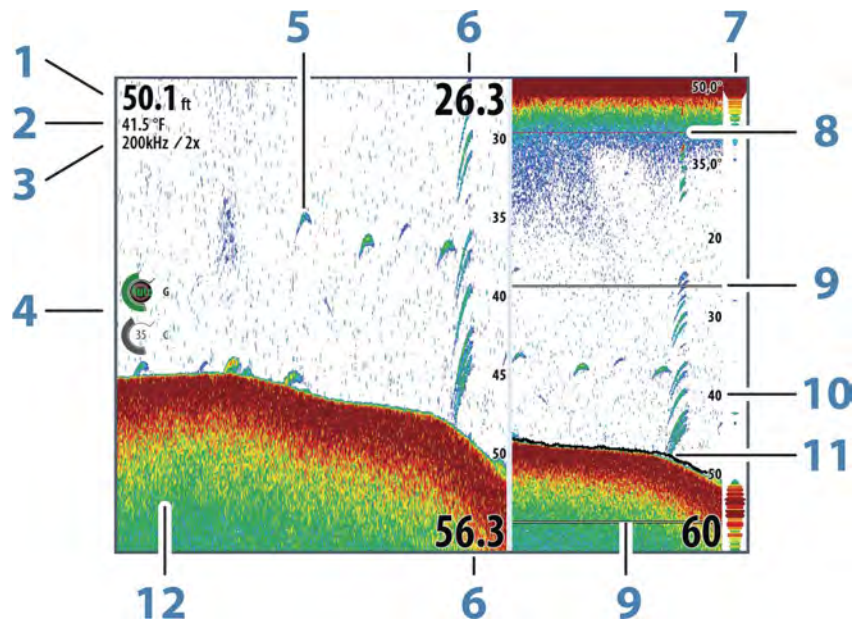

- 1 Depth
- 2 Temperature
- 3 Frequency / Zoom
- 4 Gain / Color adjustment icons
- 5 Fish arches
- 6 Upper and Lower range
- 7 A-Scope*
- 8 Temperature graph*
- 9 Zoom bars*
- 10 Range scale
- 11 Depth line*
- 12 Bottom

* Optional Echosounder items.

→ **Note:** You turn the optional Echosounder items on/off individually. Refer to "Echosounder View options" on page 79.

Multiple Echosounder

You can specify the Echosounder source for the image in the Echosounder panel. You can display two different sources simultaneously, using a split panel configuration. For more information how to select the source for a panel, refer to "Source" on page 77.

Zooming the image

You can zoom the image by:

- turning the rotary knob
- using the panel zoom icons
- pinching or spreading on the screen

Zoom level is shown on the upper left side of the image.

When zooming in, the sea floor is kept near the bottom of the screen, irrespective of whether it is in auto-range or manual range.

If the range is set considerably less than the actual depth, the unit is not able to find the bottom when zooming.

If the cursor is active, the unit zooms in where the cursor is pointed.

Zoom bar

The zoom bar is displayed when you zoom the image.

Drag the zoom bar vertically to view different parts of the water column.

Using the cursor on the image

The cursor can be used to measure a distance to a target, to mark a position, and to select targets.

By default, the cursor is not shown on the image.

When you position the cursor on the image; the screen pauses, the depth at the cursor position is shown, and the information window and the history bar are activated.

To remove the cursor and cursor elements from the panel, select **Clear cursor** or press the **X** key.

GoTo cursor

You can navigate to a selected position on the image by positioning the cursor on the panel, then using the **Goto Cursor** option in the menu.

The cursor assist function

→ **Note:** The cursor assist function is available if it is enabled. Refer to "*Customizing the long press feature*" on page 19.

The cursor assist function allows for fine tuning and precision placement of the cursor without covering details with your finger.

Activate the cursor on the panel, then press and hold your finger on the screen to switch the cursor symbol to a selection circle, appearing above your finger.

Without removing your finger from the screen, drag the selection circle to the desired position.

When you remove your finger from the screen the cursor reverts to normal cursor operation.

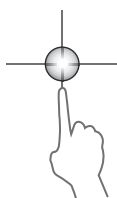

Measuring distance

The cursor can be used to measure the distance between the position of two observations on the image.

1. Position the cursor on the point from where you want to measure the distance
2. Start the measuring function from the menu
3. Position the cursor on the second measuring point
 - A line is drawn between the measuring points, and the distance is listed in the Cursor Information panel
4. Continue selecting new measuring points if required

You can use the menu to re-position the start point and the end point as long as the measuring function is active.

When you select **Finish measuring** or press the **X** key, the image resumes to normal scrolling.

Saving waypoints

You can save a waypoint at a selected location by positioning the cursor on the panel, and then doing one of the following:

- Pressing the rotary knob
- Pressing the **Mark** key
- Using the new waypoint option in the menu



Viewing history

Whenever the cursor is shown on the Echosounder panel, the scroll bar is shown at the top of the panel. The scroll bar shows the image you are currently viewing in relation to the total Echosounder image history stored.

If the scroll bar is on the far right side, it indicates that you are viewing the latest soundings. If you position the cursor to the left side of the screen, the history bar starts scrolling towards the left, and the automatic scrolling as new soundings are received is turned off.

You can view echosounder history by panning the image.

To resume normal scrolling, select **Clear cursor** or press the **X** key.

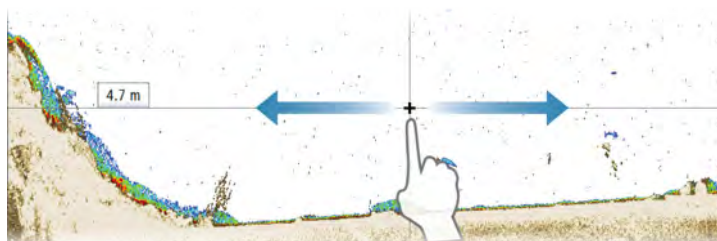

Setting up the image

Use the Echosounder menu options to set up the image. When the cursor is active, some options on the Echosounder menu are replaced with cursor mode features. Select **Clear cursor** to return to the normal Echosounder menu.

The range

The range setting determines the water depth that is visible on the screen.

Frequency

The unit supports several transducer frequencies. Available frequencies depend on the transducer model that is connected.

You can view two frequencies at the same time by selecting dual Echosounder panels from the **Home** page.

Frequency is the 'tone' the transducer transmits. Transducers are designed to operate on different frequencies as the various frequencies have different qualities.

- A low frequency, for example 50 kHz, will go deep. It generates a wide cone but is somewhat more sensitive to noise. It is good for bottom discrimination and wide area search.
- A high frequency, for example 200 kHz, offers higher discrimination and is less sensitive to noise. It is good for separating targets and for higher speed vessels.

Color and gain settings

You can also adjust the image settings from the Echosounder menu.

Gain

The gain controls the sensitivity of the Echosounder.

The more you increase the gain, the more details are shown on the image. However, a higher gain setting may introduce more background clutter on the image. If the gain is set too low, weak echoes might not be displayed.

Auto gain

The Auto gain option keeps the sensitivity at a level that works well under most conditions.

With the gain in auto mode, you can set a positive or negative offset that gets applied to the auto gain.

Color

Strong and weak echo signals have different colors to indicate the different signal strengths. The colors used depend on which palette you select.

The more you increase the Color setting, the more echoes is displayed in the color at the strong return end of the scale.

Structure options

When a StructureScan source is connected to your system, you can overlay a DownScan image on the regular echo image.

Provides options for specifying the DownScan image. This menu option is available when **Overlay downscan** is selected in Echo settings dialog. For more information see "*settings*" on page 81.

Source

Select to specify the source for the image in the selected panel.

You can display two different sources simultaneously, using a split panel configuration. Menu controls for each panel are independent.

The source can be the internal Echosounder, another MFD on the Ethernet network, or a Echosounder module. To define sources, refer to the separate NSS evo3 Installation manual.

→ **Note:** Using two transducers at the same frequency ranges can cause interference between the two, and they can show up on the image as vertical lines. To avoid this, set one transducer at one frequency range (such as Medium CHIRP) and the other transducer at a different frequency range (such as High CHIRP) using the Frequency menu option.

Pausing the image

You can pause the image, allowing you to examine it.

This function is useful when you need to position a waypoint exactly on the image, and if you are using the cursor to measure a distance between 2 elements on the image.

The pause function stops the Echosounder from pinging the transducer. The system is not collecting Echosounder data when paused in this manner.

Advanced options

The Advanced option is only available when the cursor is not active.

Noise rejection

Signal interference from bilge pumps, engine vibration and air bubbles can clutter the image.

The noise rejection option filters the signal interference and reduces the on-screen clutter.

TVG

Wave action and boat wakes can cause onscreen clutter near the surface. The TVG (Time Variable Gain) option reduces surface clutter by decreasing the sensitivity of the receiver near the surface.

→ **Note:** For optimal image return and clarity in most conditions, the default value is set to 3, the maximum (range is 0-3).

Scroll speed

You can select the scrolling speed of the image on the screen. A high scroll speed updates the image fast, while a low scroll speed presents a longer history.

→ **Note:** In certain conditions it may be necessary to adjust the scroll speed to get a more useful image. Such as adjusting the image to a faster speed when vertically fishing without moving.

Ping speed

Ping speed controls the rate the transducer transmits the signal into the water. By default, the ping speed is set to max. It may be necessary to adjust the ping speed to limit interference or to adjust for specific fishing conditions.

Start recording log data

You can start recording log data and save the file internally in the unit, or save it onto a card inserted into the unit's card reader.

The record function is activated from the **Advanced** menu option.

When the data is being recorded, there is a flashing red symbol in the top left corner and a message appears periodically at the bottom of the screen.

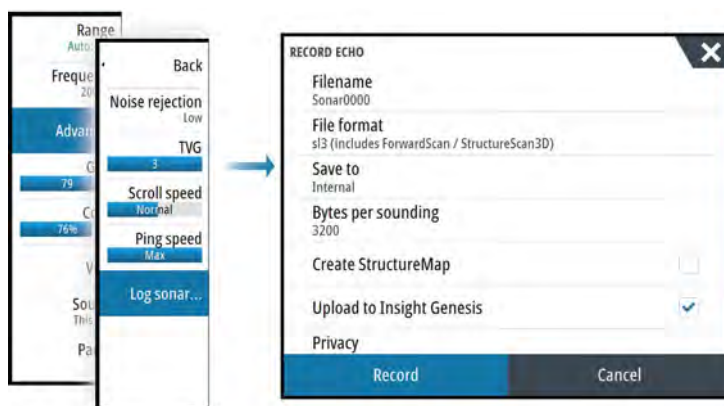

Filename

Specify the name of the recording (log).

File format

Select a file format from the drop-down, slg (Echosounder only), xtf (Structure only*), sl2 (Echosounder and Structure) or sl3 (includes ForwardScan).

→ **Note:** XTF format is for use only with select 3rd party Echosounder viewing tools.

Save to

Select whether the recording is to be saved internally or to a memory card in the card reader.

Bytes per sounding

Select how many bytes per seconds that are to be used when saving the log file. More bytes yield better resolution, but cause the record file to increase in size compared to using lower byte settings.

Create StructureMap

If StructureScan is available on the network, you can convert the .sl2 logs to StructureMap format (.smf) when recording completes. The log file can also be converted to StructureMap format from the Files option.

Upload to Insight Genesis

Files are transmitted to Insight Genesis when recording completes, if you are connected to a wireless hotspot. For information about wireless hotspots, refer to *"Wireless connection"* on page 95.

Privacy

If allowed by your selected Insight Genesis account, you can choose between setting the recorded log files as Private or Public at Insight Genesis.

Time remaining

Shows the remaining allocated space available for recordings.

Stop recording log data

Select **Stop** in the Recording Echo dialog to fully stop the recording of all echosounder data.

→ **Note:** If you have selected the **Upload to Insight Genesis** option and are connected to a wireless hotspot, your recorded files are transmitted to Insight Genesis when you select **Stop**.

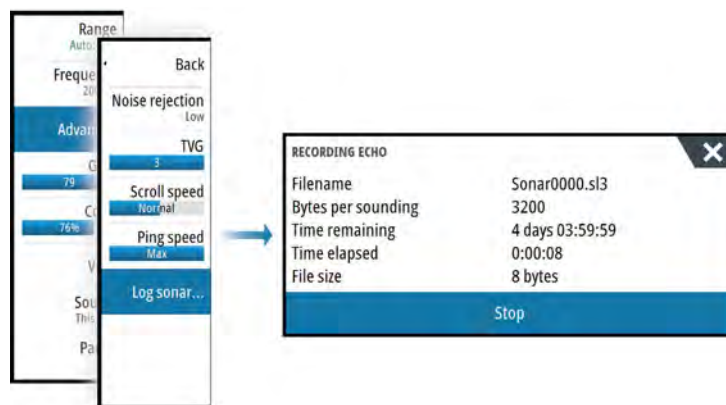

Viewing the recorded sounder data

Both internally and externally stored sounder records may be reviewed when the view sonar log option is selected in the Echo settings dialog. Refer to *"Echosounder settings"* on page 81.

The log file is displayed as a paused image, and you control the scrolling and display from the replay menu option.

You can use the cursor on the replay image, and pan the image as on a normal echo image.

If more than one channel was recorded in the selected echo file, you can select which channel to display.

You exit the replay mode by pressing the **X** key or by selecting the **X** symbol in the upper right corner of the replay image.

Echosounder View options

Split screen options

Zoom

The Zoom mode presents a magnified view of the sounder image on the left side of the panel.

By default the zoom level is set to 2x. You can select up to 8x zoom from the drop-down menu, using the +/- keys, or the zoom (+ or -) buttons.

The range zoom bars on the right side of the display shows the range that is magnified. If you increase the zooming factor the range is reduced. You see this as reduced distance between the zoom bars.

Bottom lock

The bottom lock mode is useful when you want to view echoes close to the bottom. In this mode, the left side of the panel shows an image where the bottom is flattened. The range scale is changed to measure from the seabed (0) and upwards. The bottom and the zero line are always shown on the left image, independent of the range scale. The scaling factor for the image on the left side of the panel is adjusted as described for the Zoom option.

Palettes

You can select between several display palettes optimized for a variety of fishing conditions.

Temperature graph

The temperature graph is used to illustrate changes in water temperature.

When toggled on, a colored line and temperature digits are shown on the Echosounder image.

Depth line

A depth line can be added to the bottom surface to make it easier to distinguish the bottom from fish and structures.

A-Scope

The A-scope is a display of real-time echoes as they appear on the panel. The strength of the actual echo is indicated by both width and color intensity.

Zoom bars

The zoom bars shows the range that is magnified on a split panel with zoom views.

The range zoom bars on the right side of the display shows the range that is magnified and displayed on the left side. If you increase the zooming factor, the range is reduced. You see this as reduced distance between the zoom bars.

You can move the zoom bars on the right side up or down to cause the left side image to show different depths of the water column.

Fish ID

You can select how you want the echoes to appear on the screen. You can also select if you want to be notified by a beep when a fish ID appears on the panel.

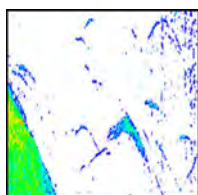

Traditional fish echoes

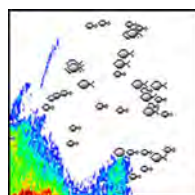

Fish symbols

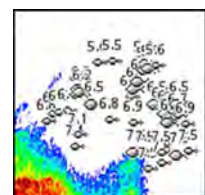

Fish symbols and depth indication

→ **Note:** Not all fish symbols are actual fish.

Echosounder settings

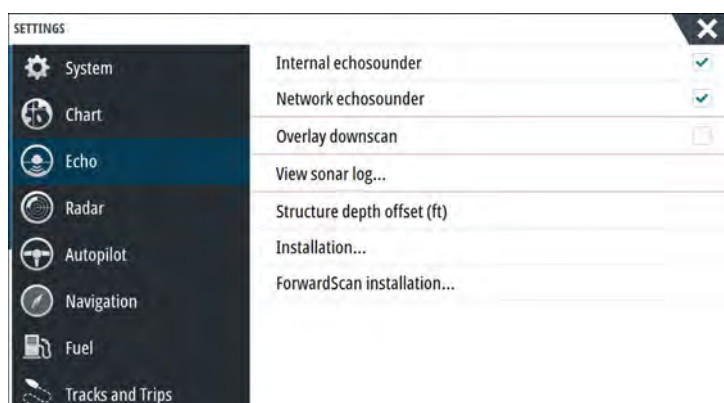

Internal Echosounder

Select to make the internal Echosounder available for selection in the Echosounder menu. For more information about panel source selection, refer to the Operator manual.

When set to off, this option disables the internal Echosounder in the unit. It will not be listed as a Echosounder source for any unit on the network. Select this option on a unit which does not have a transducer connected.

Network Echosounder

You can share the Echosounder images from this unit with other units connected on the Ethernet network.

For more information about how to setup Echosounder, refer to the separate NSS evo3 Installation manual.

Overlay downscan

When a DownScan source is connected to your system, you can overlay DownScan images on the regular Echosounder image.

When activated, the Echosounder menu expands to include basic DownScan options.

View Echosounder log

Used to view Echosounder recordings. The log file is displayed as a paused image, and you control the scrolling and display from the menu.

You can use the cursor on the image, measure distance, and set view options as on a live Echosounder image. If more than one channel was recorded in the selected Echosounder file, you can select which channel to display.

You exit the view function by selecting the **X** in the upper right corner.

Structure depth offset

Setting for Structure transducers.

All transducers measure water depth from the transducer to the bottom. As a result, water depth readings do not account for the distance from the transducer to the lowest point of the boat in the water or from the transducer to the water surface.

To show the depth from the lowest point of the boat to the bottom, do the following. Before setting the Structure offset, measure the distance from the structure transducer to the lowest point of the boat in the water. If, for example, the distance is 0.3 m (1 ft), it will be input as (minus) -0.3 m (-1 ft).

To show the depth from the water surface to the bottom, do the following. Before setting the Structure offset, measure the distance from the structure transducer to the water surface. If, for example, the distance is 0.3 m (1 ft), it will be input as (plus) 0.3 m (1 ft).

A setting of 0 (zero) causes the depth displayed to be the distance from the transducer to the bottom.

Installation

Used for defining Echosounder sources available for selection in the Source menu option. For information about defining sources, refer to the separate NSS evo3 Installation manual. For information about Source selection, refer to "*Source*" on page 77.

ForwardScan Installation

Used for ForwardScan installation and setup. Refer to the "*ForwardScan setup*" on page 92.

11

StructureScan

StructureScan uses high frequencies to provide a high resolution, picture-like image of the seabed.

The unit has built-in StructureScan.

- **Note:** You must have a StructureScan HD, TotalScan or StructureScan 3D transducer installed to use StructureScan features.
- **Note:** Connect StructureScan transducers to the Sonar2 port only.

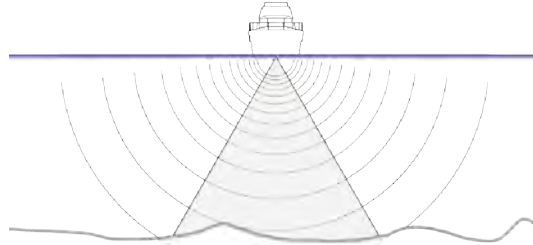

The StructureScan image

The view

The StructureScan panel can be set up as a DownScan image, or showing left/right side scanning.

The DownScan image can also be added as an overlay to the traditional Echosounder image.

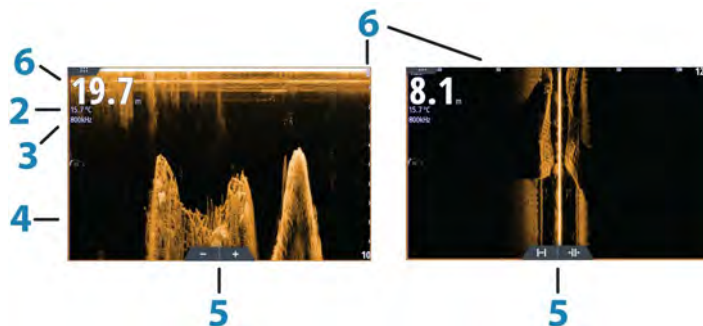

- 1 Depth
 - **Note:** The depth reading depends on the **Structure depth offset** setting, refer to "*Structure depth offset*" on page 81
- 2 Temperature
- 3 Frequency
- 4 Bottom
- 5 Zoom (downscan) / Range (sidescan) icons
- 6 Range scale

Zooming the StructureScan image

You can zoom a StructureScan image by:

- turning the rotary knob when the cursor is not active
- using the panel zoom icons
- by pinching or spreading on the screen

Zoom level is shown on the upper left side of the panel.

Using the cursor on the StructureScan panel

By default, the cursor is not shown on the StructureScan image.

When you position the cursor on a DownScan image, the screen pauses, the cursor information window and the history bar are activated. On a DownScan image, the depth is shown at cursor position.

When you position the cursor on a SideScan image, the screen pauses, and the cursor information window is activated. On a SideScan image, the left/right distance from the vessel to the cursor are shown at the cursor position.

GoTo cursor

You can navigate to a selected position on the image by positioning the cursor on the panel, then using the **Goto Cursor** option in the menu.

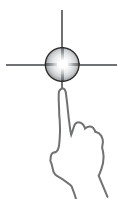

The cursor assist function

→ **Note:** The cursor assist function is available if it is enabled. Refer to "*Customizing the long press feature*" on page 19.

The cursor assist function allows for fine tuning and precision placement of the cursor without covering details with your finger.

Activate the cursor on the panel, then press and hold your finger on the screen to switch the cursor symbol to a selection circle, appearing above your finger.

Without removing your finger from the screen, drag the selection circle to the desired position.

When you remove your finger from the screen the cursor reverts to normal cursor operation.

Measuring distance

The cursor can be used to measure the distance between the position of two observations on the image.

1. Position the cursor on the point from where you want to measure the distance
2. Start the measuring function from the menu
3. Position the cursor on the second measuring point
 - A line is drawn between the measuring points, and the distance is listed in the Cursor Information panel
4. Continue selecting new measuring points if required

You can use the menu to re-position the start point and the end point as long as the measuring function is active.

When you select **Finish measuring** or press the **X** key, the image resumes to normal scrolling.

Saving waypoints

You can save a waypoint at a selected location by positioning the cursor on the panel, and then doing one of the following:

- Pressing the rotary knob
- Pressing the **Mark** key
- Using the new waypoint option in the menu



Viewing StructureScan history

Whenever the cursor is active on a StructureScan panel, the scroll bar is shown on the panel. The scroll bar shows the image you are currently viewing in relation to the total StructureScan image history stored. Depending on the view selected, the scroll bar is on the far right side (SideScan) or at the top of the screen (DownScan).

You can pan the image history by dragging up/down (SideScan) or left/right (DownScan).

To resume normal StructureScan scrolling, press **Clear cursor**.

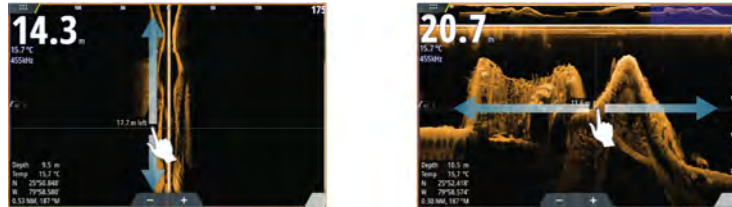

Setting up the StructureScan image

Range

The range setting determines the water depth and SideScan range that is visible on the screen.

Auto range

When the range is set to Auto the system automatically sets the range depending on the water depth.

Preset range levels

You can select between several preset range levels.

Custom range

This option allows you to manually set both upper and lower range limits.

StructureScan frequencies

StructureScan supports two frequencies. 455 kHz provides ideal range and image quality in most situations, while 800kHz is used to provide higher detail in shallow water.

Contrast

Determines the brightness ratio between light and dark areas of the screen.

To adjust the contrast setting:

1. Select the contrast icon or activate the contrast option in the menu to display the color adjustment bar
2. Drag the bar or use the rotary knob to set the value.

Palettes

You can select between several display palettes optimized for a variety of fishing conditions.

View

You can set up the StructureScan page as a DownScan image, left only, right only, or left/right side scanning.

Pausing the StructureScan image

You can pause the StructureScan image, allowing you to examine the structures and other images in more depth and detail.

This function is useful when you need to position a waypoint exactly on the StructureScan image, and if you are using the cursor to measure a distance between 2 elements on the image.

Advanced StructureScan settings

TVG

Wave action and boat wakes can cause onscreen clutter near the surface. The TVG (Time Variable Gain) option reduces surface clutter by decreasing the sensitivity of the receiver near the surface.

→ **Note:** For optimal image return and clarity in most conditions, the default value is set to 3, the maximum (range is 0-3).

Flipping the Structure image left/right

If required, the left/right SideScanning images can be flipped to match the direction of the transducer installation.

Range Lines

Range lines can be added to the image to make it easier to estimate depth (Downscan) and distance (SideScan).

Recording StructureScan data

You can record StructureScan data and save the file internally in the NSS evo3 unit, or onto memory card as described in "*Start Recording echosounder data*" on page 78.

12

StructureMap

The StructureMap feature overlays SideScan images from a StructureScan source on the map. This makes it easier to visualize the underwater environment in relation to your position, and aids in interpreting SideScan images.

The StructureMap image

The example below shows a chart panel with Structure overlay, combined with a traditional SideScan panel.

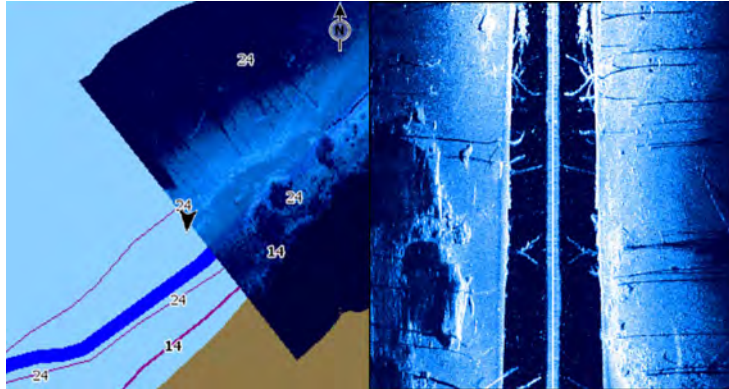

You move around in the chart as usual when you have a Structure overlay:

- zoom the chart and the scanned image by turning the rotary knob, by using the zoom icons, or by pinching or spreading on the screen
- move the chart to view the scanned image by dragging it in the desired direction

Pressing the **X** key or selecting the **Clear cursor** option removes the cursor from the panel, and the chart center is positioned at the vessel.

Activating Structure overlay

1. Turn on Structure overlay from the chart menu
 - The chart menu is increased to show Structure options
 - Structure data starts to appear on the chart screen as soon as Structure overlay is enabled
 2. Select Structure source
 - Live data is default
- **Note:** Structure overlay can also be activated by selecting a saved StructureMap file in the files browser.

StructureMap sources

Two sources can be used to overlay Structure logs on the charts, but only one can be viewed at a time:

- Live data - Used when StructureScan data is available on the system.
- Saved files - These are recorded StructureScan (*.sl2) data that are converted to StructureMap (*.smf) format. Saved *.smf files can be used even if no StructureScan sources are connected.

Live source

When live data is selected, the SideScan imaging history is displayed as a trail behind the vessel icon. The length of this trail varies depending on available memory in the unit and range settings. As the memory fills up, the oldest data is automatically deleted as new data is added. When increasing the search range, the ping speed of the StructureScan transducer is reduced, but the width and the length of the image history is increased.

→ **Note:** Live mode does not save any data. If the unit is turned off, all recent data is lost.

Saved files

When Saved files are selected, the StructureMap file is overlaid on the map based on position information in the file.

If the chart scale is large, the StructureMap area is indicated with a boundary box until the scale is large enough to show Structure details.

Saved mode is used to review and examine StructureMap files, and to position the vessel on specific points of interest on a previous scanned area.

→ **Note:** When saved files are used as the source, all StructureMap files found on the memory card and in the system's internal memory are displayed. If there is more than one StructureMap of the same area, the images overlap and clutter the chart. If several logs of the same area are required, the maps should be put on separate memory cards.

StructureMap tips

- To get a picture of taller structures (a wreck, etc.) — do not drive over it, instead, steer the boat so the structure is on the left or right side of your vessel.
- Do not use Autorange when using StructureScan. Set your structure range to a significantly greater level (two-to-three times) than the water depth to ensure a complete scan and to maximize conversion accuracy.
- Do not overlap history trails when conducting a side-by-side scan of an area.

Recording StructureScan data

StructureScan data can be recorded from a chart panel with Structure overlay enabled.

StructureScan recordings can also be started from a StructureScan panel.

When StructureScan data is being recorded, there is a flashing red symbol and a message appears periodically at the bottom of the screen.

→ **Note:** The message includes information about file size. Keep the size of your logs to 100MB or less to allow for faster file conversion.

The recording is stopped by re-selecting the record function.

Converting StructureScan data to StructureMap format

A StructureScan log file (.sl2) is converted to StructureMap format (.smf) after recording from the recording dialog, or from the files browser.

You can create standard or high resolution files. High resolution .smf files capture more detail, but take longer to convert and are larger than standard resolution files.

To save disc space it is recommended to remove the StructureScan (.sl2) files after conversion.

Using StructureMap with mapping cards

StructureMap allows you to maintain full chart capability and can be used with embedded cartography as well as Navionics, Insight and other third-party charting cards compatible with the system.

When using StructureMap with mapping cards, copy the StructureMap (.smf) files to the unit's internal memory. We recommend keeping copies of StructureMap files on external mapping cards.

Structure options

You adjust the StructureMap settings from the Structure options menu. The menu is available when Structure overlay is enabled.

Not all options are available when saved StructureMap files are used as the source. Unavailable options are greyed.

Range

Sets the search range.

Transparency

Sets the opaqueness of the Structure overlay. With minimum transparency settings, the chart details are almost hidden by the StructureMap overlay.

Palette

Selects Structure palette.

Contrast

Determines the brightness ratio between light and dark areas of the screen.

Water column

Shows/hides the water column in Live mode.

If turned OFF schools of bait fish might not be seen on the SideScan image.

If turned ON the accuracy of the SideScan image on the map might be affected by the water depth.

Frequency

Sets the transducer frequency used by the unit. 800 kHz offers the best resolution, while 455 kHz has greater depth and range coverage.

Noise rejection

Signal interference from bilge pumps, engine vibration and air bubbles can clutter the sonar screen. The noise rejection option filters the signal interference and reduces on-screen clutter.

Clear live history

Clears existing live history data from the screen and begins showing only the most current data.

Record data

Records StructureScan data.

Source

Selects StructureMap source.

13

ForwardScan

ForwardScan sonar is a navigational aid that helps you monitor the underwater environment in front of your vessel while carrying out slow speed maneuvers.

To use the ForwardScan feature you must have a ForwardScan transducer mounted on your vessel. For installation instructions, refer to the ForwardScan transducer installation manual.

The ForwardScan transducer can be connected to a SonarHub and shared over the Ethernet network. You can also connect the ForwardScan transducer to the Sonar2 port on your NSS evo3 unit, leaving the Sonar1 port available for a CHIRP transducer.

→ **Note:** When a ForwardScan transducer connected to the NSS evo3 is in use. Transducers connected to Sonar1 port will be paused.

⚠ **Warning:** Do not rely on this equipment as your principle source of navigation or hazard detection.

⚠ **Warning:** Do not use this equipment to gauge depth or other conditions for swimming or diving.

The ForwardScan image

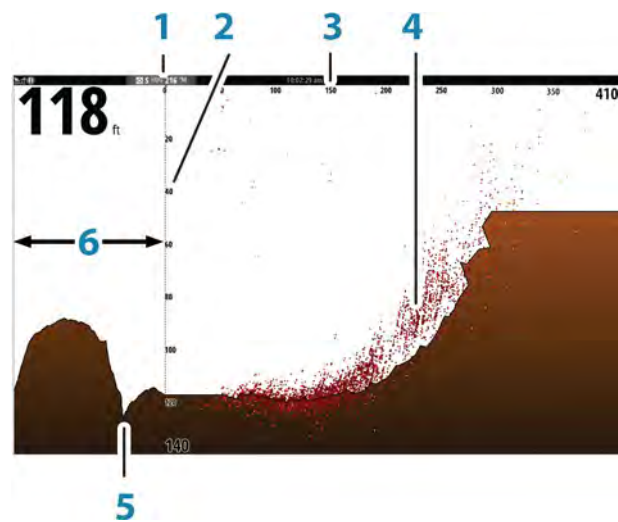

- 1 Transducer location shown as the origin on the page
- 2 Depth range scale and vessel position
- 3 Forward range scale
- 4 Point data
- 5 Bottom
- 6 Depth history

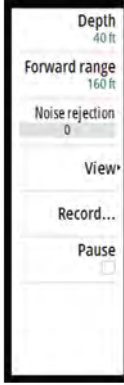

Setting up the ForwardScan image

Depth

Controls depth range. Depth range is set to auto mode by default.

Forward range

Controls the forward looking search range. Maximum Forward range is 91 meters (300 feet).

Noise Rejection

Filters out signal interference and reduces on-screen clutter.

Record

Records ForwardScan sonar logs.

Pause

Pauses forward-looking Echosounder transmissions.

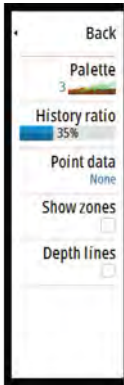

ForwardScan view options

Palette

Several display palettes are available for a variety of water conditions.

History ratio

Controls how much Echosounder history is shown behind the boat. The higher the ratio, the more history will be shown.

Point data

By default, ForwardScan only shows the bottom. Select the Point data menu option to specify to view no sonar data points, all sonar data points, or only points (Objects) in the water column.

Show zones

Displays warning zones (yellow) and critical zones (red) on the screen. Refer to "*Critical forward range and Critical depth*" on page 92.

Depth lines

Displays lines on the screen that make it easier to quickly estimate depth and the underwater objects.

Heading extension

You can use the heading extension to monitor ForwardScan on the chart panel. Heading extension colors are based on the ForwardScan alarm values.

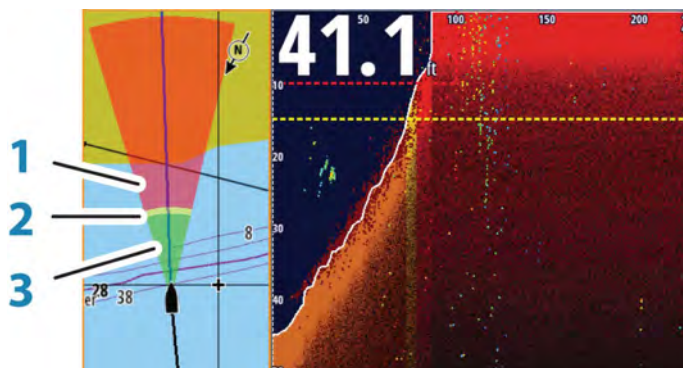

ForwardScan extension

- 1 Red - Critical
- 2 Yellow - Warning
- 3 Green - Safe

Select ForwardScan in the Chart Settings dialog to view the ForwardScan heading extension on the chart panel.

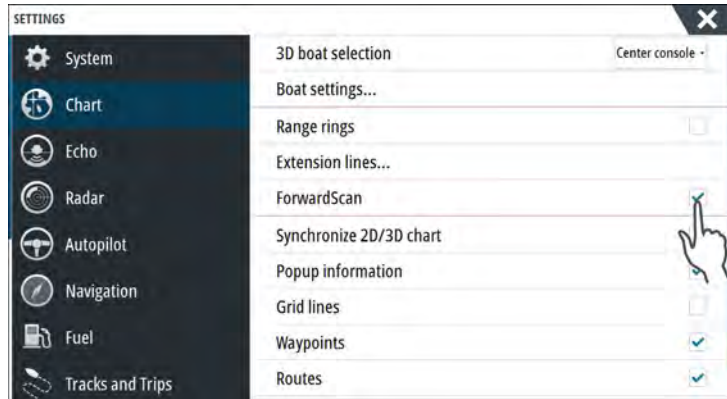

ForwardScan setup

Specify the setup in the **ForwardScan installation** dialog.

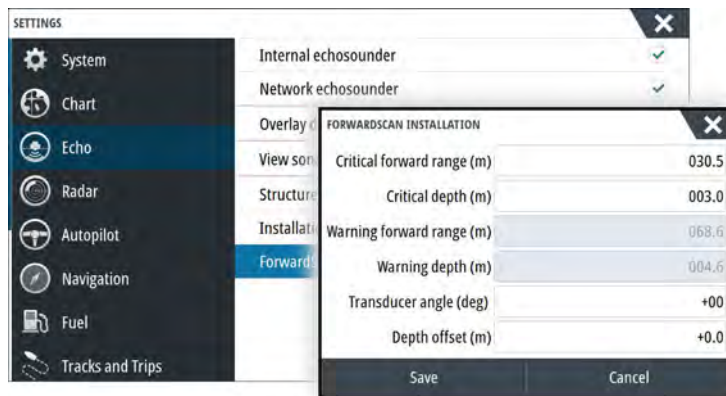

Critical forward range and Critical depth

Critical Forward Range and Critical Depth are user-selected thresholds that define a critical zone forward of your vessel.

If you travel into water shallow enough to cross into the critical zone, the Critical Zone alarm is activated. You can display the critical warning zones by activating the **Show zones** menu option.

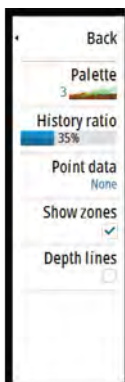

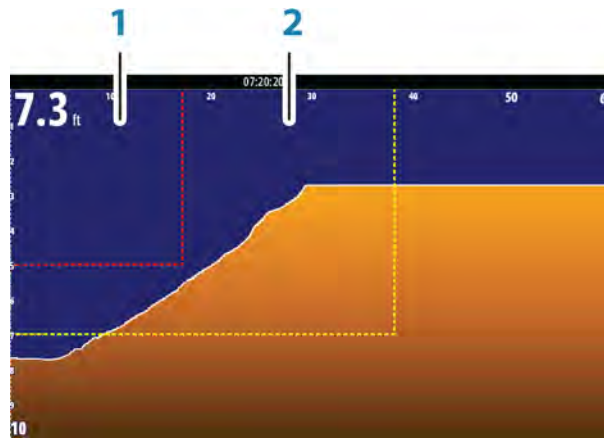

ForwardScan image with Show zones active

- 1 Critical zone
- 2 Warning zone

Warning Forward Range and Warning Depth values are based on the selected Critical Forward Range and Critical Depth values.

→ **Note:** To receive Critical Zone alerts, enable ForwardScan alarm in the Alarm settings dialog. For more information about enabling alarms, refer to Alarms.

Transducer angle

We recommend installing the transducer vertical to the waterline. In cases where that is not possible, the Transducer Angle setting helps offset the difference between the transducer angle and the waterline.

The angle can be adjusted from 0 (vertical) to 20 degrees.

⚠ **Warning:** Adjustments to the transducer angle value should be done with caution. Large variations in the transducer angle value can distort depth data, increasing the risk of striking underwater obstructions.

Depth offset

All transducers measure water depth from the transducer to the bottom. As a result, water depth readings do not account for the distance from the transducer to the lowest point of the boat (for example; bottom of the keel, rudder, or skeg) in the water or from the transducer to the water surface.

Before setting the offset, measure the distance from the transducer to the lowest point of the boat in the water or from the transducer to the water surface.

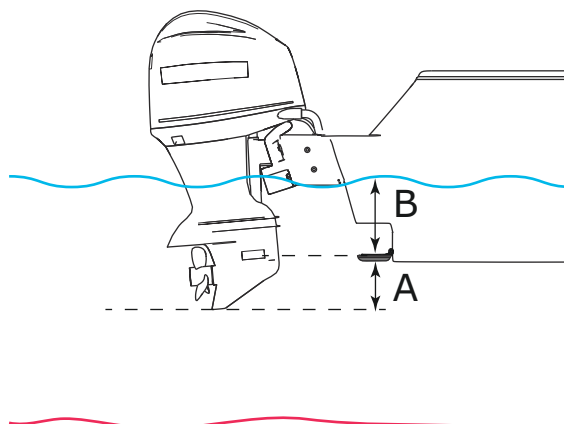

- A** Lowest point of vessel offset: Set the distance from the transducer to the lowest point of the boat in the water - this should be set as a negative value. For example, -0.3 m (-1 ft).
- B** Depth below surface (waterline) offset: Set the distance from the transducer to the surface - this should be set as a positive value. For example, +0.5 m (+1.77 ft).

For depth below transducer, set the offset to 0.

14

Wireless connection

GoFree wireless connectivity gives you the ability to:

- Use a wireless device to remotely view (smartphone and tablet) and control the system (tablet only).
- Access the GoFree Shop.
- Upload your Echosounder logs to create custom maps at Insight Genesis.
- Download software updates
- Connect to third party applications



→ **Note:** Maps, charts, software updates, and other data files can be large. Your data provider may charge you based on the amount of data you transfer. If you are unsure contact the service provider for information.

The unit includes Built-in wireless functionality for connecting to the internet and wireless devices such as smartphones and tablets.

Initial configuration and setup of the built-in wireless functionality is described in your system's Installation Manual.

Connect and disconnect from a wireless hotspot

To connect to a wireless hotspot, select the Wireless option in the System Controls dialog and then select Not Connected. This opens the Wireless Devices dialog. Use this dialog to select the desired hotspot, enter the login information and then select Connect. Connecting to a wireless hotspot changes the wireless mode to **Client mode**. In this mode, you can access the GoFree Shop.

To disconnect from a wireless hotspot, select the Wireless option in the System Controls dialog, then select Connected *hotspot_name*, and then Disconnect. This changes the wireless mode to **Access point mode**. In this mode, you can connect a wireless device so that Apps such as GoFree Link can access the vessel's navigation information.



GoFree Shop

The wireless must be connected to an external wireless hotspot in order to access the GoFree Shop.

At the GoFree Shop you can browse, purchase and download compatible content for your system including navigation charts and Insight Genesis Maps. When you log on, the system automatically gives you a notification if a new software version is available for your system. If an update is available, you can download it to a card slot or defer the download until later. If you defer the download until later, the notification is available in the About dialog accessible from the System Settings.

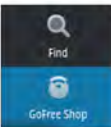

GoFree Link

The wireless functionality lets you use a wireless device to remotely view (smartphone and tablet) and control the system (tablet only). The system is viewed and controlled from the wireless device by the GoFree Link Apps downloaded from their relevant Application store. When remote control is accepted, the active page is mirrored to the wireless device.

→ **Note:** To use smartphones and tablets to view and control the system, wireless functionality must be disconnected from the wireless hotspot (in **Access point mode**).

→ **Note:** For safety reasons, Autopilot and CZone functions cannot be controlled from a wireless device.



Connecting a tablet

Install the GoFree App on the tablet before following this procedure.

1. Set the internal wireless to **Access Point** mode. To do this, select the **Wireless devices** page in the Wireless settings dialog and then select the Internal wireless. Next, select the **Mode** option and then select **Internal Access Point**.
2. Select a device on the **Wireless devices** page to view its network key.
3. Navigate to the wireless network connection page on the tablet, and find the unit or GoFree wireless **xxxx** network. If more than one is in range, review the **Wireless devices** page on the unit to confirm which wireless device is connected to the unit.
4. Enter the Network Key in the tablet to connect to the network.
5. Open the GoFree application - the unit should be automatically detected. The name displayed will be either the default, or that assigned in the Device Name setting. If the unit does not appear, follow the on screen instructions to manually find the device.
6. Select the graphic icon of the unit. The unit displays a prompt similar to the following:

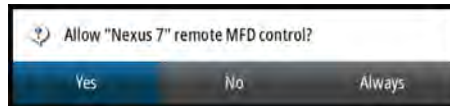

7. Select **Yes** for one-time connection, or **Always** if device is to be remembered for regular connection. This setting can be changed later if required.
- **Note:** The internal wireless module only supports GoFree connection to itself. Other units connected on the network are not visible.

Connecting a smartphone

Install the GoFree App on the smartphone before following this procedure.

1. Set the internal wireless to **Access Point** mode. To do this, select the **Wireless devices** page in the Wireless settings dialog and then select the unit's Internal Wireless. Next, select the **Mode** option and then select **Internal Access Point**.
2. Select a device on the **Wireless devices** page to view its Network Key.
3. Navigate to the wireless network connection page on the smartphone, and find the unit or GoFree wireless **xxxx** network. If more than one is in range, review the **Wireless devices** page from the unit's Wireless settings dialog to confirm which wireless device is connected to the unit.
4. Enter the Network Key in the smartphone to connect to the network.
5. Open the GoFree application on the smartphone, the unit should be automatically detected. The name displayed will be either the default, or that assigned in the Device Name setting. If the unit does not appear, follow the on screen instructions to manually find the device.

The MFD's display is shown on the smartphone. To change the MFD's display on the smartphone, use the MFD to change the display on the MFD. The display change on the MFD is reflected on the smartphone.

Uploading log files to Insight Genesis

To upload a recorded Echosounder log file to Insight Genesis, select the file you want to upload from the Files panel and select the upload to Insight Genesis option.

- **Note:** You must be connected to a wireless hotspot to upload recorded log files to Insight Genesis.
- **Note:** Recorded log files can also be uploaded to Insight Genesis if you have specified **Upload to Insight Genesis** in the Record Echo dialog. For more information, refer to "Start Recording log data" on page 78.



Wireless settings

Provides configuration and setup options for the wireless functionality.

For more information, refer to the NSS evo3 Installation Manual.



Connect to a wireless hotspot

Displays the Wireless device dialog that you can use to connect the wireless functionality to a wireless hotspot.

Remote controllers

When a wireless device (smart phone or tablet) is connected, it should appear in the Remote controllers list. Selecting **Always allow** means the device can automatically connect without needing a password each time. This menu also allows you to disconnect devices that no longer require access.

Wireless devices

This dialog shows the internal wireless and any connected WIFI-1 devices, as well as their IP and channel number. Selecting the internal wireless or a WIFI-1 device provides additional detail.

To view and change internal wireless detail values (Network Name (SSID), Network Key, or Channel) the internal wireless must be in **Access Point** (Internal Wifi) mode. To select a network (hotspot) to connect to, the internal wireless must be in **Client Mode**. Use the Mode option to change modes.

Client settings

Displays information about the wireless hotspot your unit is connected to or the last one your unit was connected to. You can select the hotspot in the dialog to set it as a hotspot you want to always connect to when in range or you can select to delete it.

Advanced

Initiates the Iperf and DHCP Probe tools that help in fault-finding and setting up the wireless network.

→ **Note:** Iperf and DHCP Probe are tools provided for diagnostic purposes by users familiar with network terminology and configuration. Navico is not the original developer of these tools, and does not provide support related to their use.

15

AIS

If a compatible AIS (Automatic Identification System) source is connected to the system, then any targets detected by these devices can be displayed and tracked. You can also see messages and position for DSC transmitting devices within range.

AIS targets can be displayed as overlay on radar and chart images, making this feature an important tool for safe travelling and collision avoidance.

You can set alarms to notify you if an AIS target gets too close or if the target is lost.





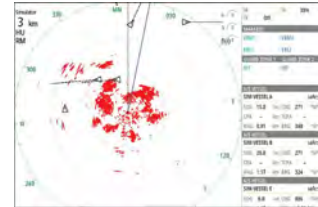



AIS vessels on a chart panel



AIS vessels on a radar panel

AIS target symbols

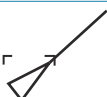
The system uses the AIS target symbols shown below:

	Sleeping AIS target (not moving or at anchor).
	Moving and safe AIS target with course extension line.
	Dangerous AIS target, illustrated with bold line. A target is defined as dangerous based on the CPA and TCPA settings. Refer to <i>"Defining dangerous vessels"</i> on page 102.
	Lost AIS target. When no signals have been received within a time limit, a target is defined as lost. The target symbol represents the last valid position of the target before the reception of data was lost.
	Selected AIS target, activated by selecting a target symbol. The target returns to the default target symbol when the cursor is removed from the symbol.
	AIS SART (AIS Search And Rescue Transmitter).

Viewing information about AIS targets

Searching for AIS items

You can search for AIS targets by using the **Find** option in the Tools panel.

From a chart panel you can search for AIS targets by using the **Find** option in the menu. If the cursor is active, the system searches for vessels around the cursor position. Without an active cursor, the system searches for vessels around your vessel's position.



Viewing information about single AIS targets

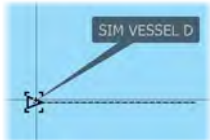

When you select an AIS icon on the chart or radar panel the symbol changes to Selected target symbol, and the vessel's name is displayed.

You can display detailed information for a target by selecting the AIS pop-up, or from the menu when the target is selected.



AIS information on radar panels



The radar data bar includes information on up to 3 AIS targets.

The targets are listed with the closest target on top, and are color coded to indicate target status.

Calling an AIS vessel

If the system includes a VHF radio supporting DSC (Digital Select Calling) calls over NMEA 2000, you can initiate a DSC call to other vessels from the NSS evo3.

The call option is available in the **AIS Vessel Details** dialog, and in the **Vessel** status dialog activated from the **Tools** panel.

From the **Call** dialog you can change channel or cancel the call. The **Call** dialog is closed when the connection is established.

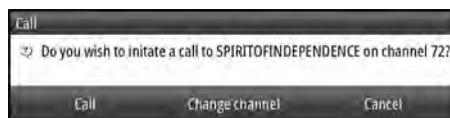

AIS SART



When an AIS SART (Search and Rescue beacon) is activated, it starts transmitting its position and identification data. This data is received by your AIS device.

If your AIS receiver is not compliant with AIS SART, it interprets the received AIS SART data as a signal from a standard AIS transmitter. An icon is positioned on the chart, but this icon is an AIS vessel icon.

If your AIS receiver is compliant with AIS SART, the following takes place when AIS SART data is received:

- An AIS SART icon is located on the chart in the position received from the AIS SART
- An alarm message is displayed

If you have enabled the siren, the alarm message is followed by an audible alarm.

→ **Note:** The icon is green if the received AIS SART data is a test and not an active message.

AIS SART alarm message

When data is received from an AIS SART, an alarm message is displayed. This message includes the AIS SART's unique MMSI number, and its position, distance, and bearing from your vessel.

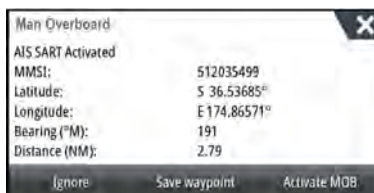

You have the following options:

- Ignore the alarm
 - The alarm is muted and the message closed. The alarm does not reappear
- **Note:** If you ignore the alarm, the AIS SART icon remains visible on your chart, and the AIS SART remains in the Vessels list.
- Save the waypoint
 - The waypoint is saved to your waypoint list. This waypoint name is prefixed with MOB AIS SART - followed by the unique MMSI number of the SART. For example, MOB AIS SART - 12345678.
- Activate the MOB function
 - The display switches to a zoomed chart panel, centered on the AIS SART position
 - The system creates an active route to the AIS SART position
- **Note:** If the MOB function is already active, this will be terminated and replaced by the new route towards the AIS SART position!
- **Note:** If the AIS stops receiving the AIS SART message, the AIS SART remains in the Vessels list for 10 minutes after it receives the last signal.

If you select the AIS SART icon on the chart panel, then you can see the AIS MOB details.

Vessel alarms

You can define several alarms to alert you if a target shows up within predefined range limits, or if a previously identified target is lost.

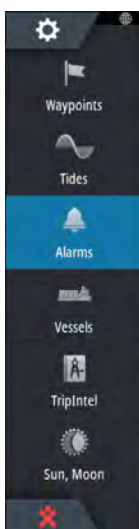

Dangerous vessel

Controls whether an alarm will be activated when a vessel comes closer than the distance for CPA within the time limit for TCPA. Refer to *"Defining dangerous vessels"* on page 102.

AIS vessel lost

Sets the range for lost vessels. If a vessel is lost within the set range, an alarm occurs.

→ **Note:** The check box controls whether the alarm pop-up box is displayed and if the siren goes on. The CPA and TCPA define when a vessel is dangerous regardless of the enabled or disabled state.

Vessel message

Controls whether an alarm will be activated when a message is received from an AIS target.

Vessel settings

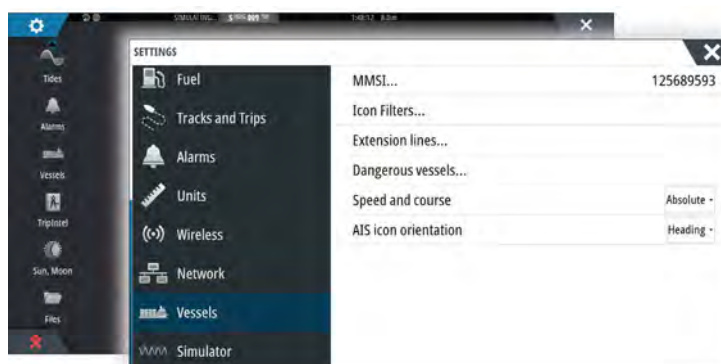

Your vessel's MMSI number

You need to have your own MMSI (Maritime Mobile Service Identity) number entered in the system to receive addressed messages from AIS and DSC vessels.

It is also important to have the MMSI number entered to avoid seeing your own vessel as an AIS target on the chart.

→ **Note:** The Vessel message option in the alarm settings must be toggled on for any MMSI message to be displayed.

Icon filters

By default, all targets are shown on the panel if an AIS device is connected to the system.

You can select not to show any targets, or to filter the icons based on security settings, distance, and vessel speed.

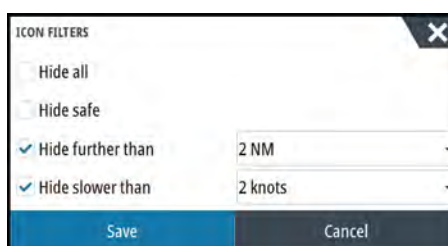

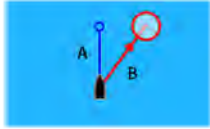

Extension lines

The length of the extension lines for your vessel and for other vessels can be set by the user.

- A: Heading
- B: Course Over Ground (COG)

The length of the extension lines is either set as a fixed distance, or to indicate the distance the vessel will move in the selected time period. If no options are turned on for **This vessel** then no extension lines are shown for your vessel.



Your own vessel heading information is read from the active heading sensor, and COG information is received from the active GPS.

For other vessels COG data is included in the message received from the AIS system.

Defining dangerous vessels

You can define an invisible guard zone around your vessel. When a target comes within the set limits, the symbol changes to the Dangerous target symbol. An alarm is triggered if activated in the Alarm settings panel.

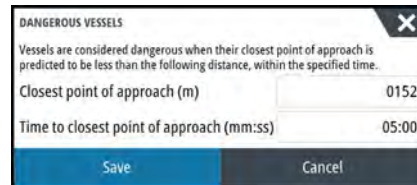

Speed and course indication

The extension line can be used to indicate speed and course for targets, either as absolute (true) motion in the chart or relative to your vessel.

A different line style is used on the extension lines to indicate motion, as shown below.



AIS vessels shown with Absolute motion



AIS vessels shown with Relative motion

AIS icon orientation

Sets the orientation of the AIS icon, either based on heading or COG information.

16

Instrument panels

The Instruments panels consist of multiple gauges - analog, digital and bar - that can be customized to display selected data. The Instruments panel displays data on dashboards, and you can define up to ten dashboards within the Instruments panel.

→ **Note:** To include fuel/engine information, engine and tank information has to be configured from the Settings panel.

Dashboards

A set of dashboard styles are predefined to display vessel, navigation, and angler information. You switch between the panel's dashboards by selecting the left and right arrow buttons on the panel. You can also select the dashboard from the menu.



Vessel dashboard

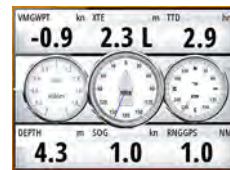

Navigation dashboard

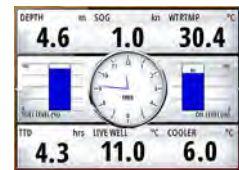

Angler dashboard

→ **Note:** Additional dashboards can be activated from the menu if other systems (e.g. CZone) are present on the network.

Customizing the Instruments panel

You can customize the Instruments panel by changing the data for each of the gauges in the dashboard, by changing the dashboard layout, and by adding new dashboards. You can also set limits for analog gauges.

All edit options are available from the Instruments panel menu.

Available editing options depend on which data sources are connected to your system.

Edit a dashboard

Activate the dashboard you want to edit, then either press and hold on the gauge you want to change and select the information to be displayed or do the following:

1. Activate the menu
2. Select the edit option
3. Select the gauge you want to change. Selected gauge is indicated with a colored background
4. Select information to be displayed, configure limits, and eventually change the source for the information
5. Save your changes by selecting the save option in the menu

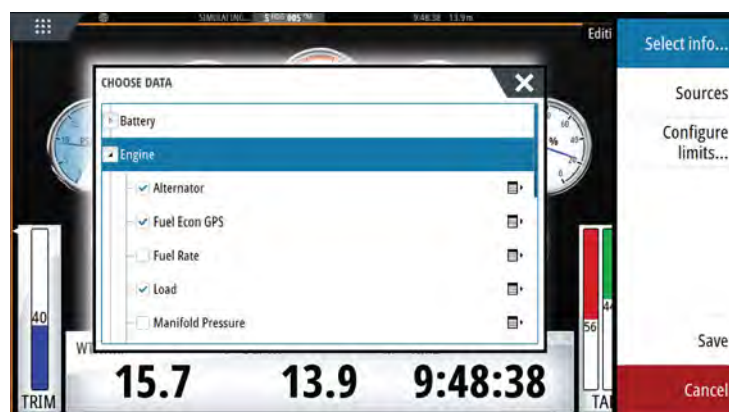
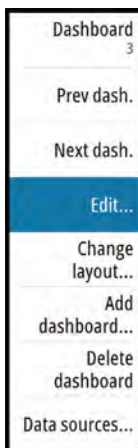

17

Audio

If a SonicHub server, a FUSION marine entertainment system, or NMEA 2000 audio system is connected to the NMEA 2000 network, you can use the NSS evo3 to control and customize the audio system on your vessel.

When connected to a WM-3 Satellite module with an active subscription, you can include SiriusXM products on your system. You can also connect a SiriusXM radio to a FUSION system. Sirius audio and weather service covers inland U.S. waters and coastal areas into the Atlantic and Pacific oceans, Gulf of Mexico, and the Caribbean Sea. The SiriusXM products received vary depending on your selected subscription package. For more information refer to www.siriusXM.com.

Before you can start using your audio equipment, it must be installed according to the NSS evo3 Installation manual and to the documentation included with the audio device.

Enabling audio

A compatible audio device connected to the NMEA 2000 network should automatically be identified by the system. If not, enable the feature from the **Advanced Settings** dialog.



SonicHub 2

A SonicHub 2 connected to the NMEA 2000 network is supported.

SonicHub 2 Device Information

Open the Network Settings dialog and select the SonicHub 2 device in the Device list. This opens the SonicHub 2 Device Information dialog.



Configure

Select to configure the device.

Upgrade

Updates the device software.

→ **Note:** A USB memory stick with the software upgrade must be plugged into the device. Periodic software updates may be available from the product website. Detailed instructions for how to install the software are included with the upgrade files.

Factory Reset

Resets the device to factory defaults.

SonicHub 2 is Bluetooth enabled

The SonicHub 2 is a Bluetooth enabled device. You can use the SonicHub 2's built-in Bluetooth wireless to connect it to Bluetooth enabled audio devices.

To pair the SonicHub 2 to a Bluetooth enabled device select the Bluetooth devices icon in the **Controls** menu. Choose the Bluetooth device you want to pair to from the list of available devices and then select Pair.

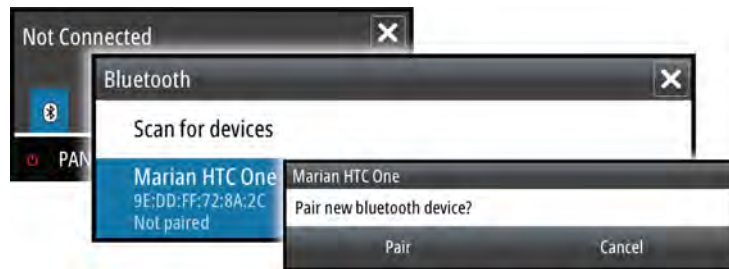

The SonicHub 2 connects to the paired device.



Connecting and disconnecting paired devices

The SonicHub 2 automatically connects to a device when you pair them. You can pair it to several devices but only one device can be connected at a time.

You can manually disconnect and connect the SonicHub 2 to paired devices.

To disconnect a paired device, select the paired device in the device list and then select **Disconnect**.

To connect to a paired device, select the paired device in the device list and then select **Connect**.

Pandora

The SonicHub 2 supports streaming music from Pandora from an Android device (over Bluetooth) or IOS device (over USB and Bluetooth).

→ **Note:** You must be in a valid location to use Pandora. Refer to the Pandora website for more information.

Use menu controls to run Pandora on the smart device.

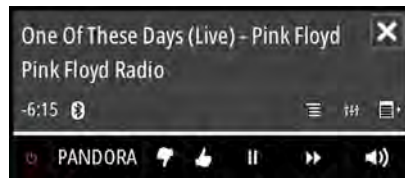

The Audio panel





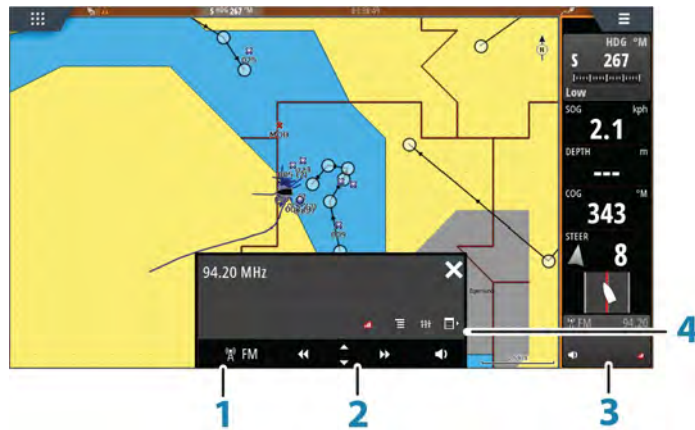

You activate the audio panel by activating the audio tile in the Instrument bar.

The control buttons, tools and options vary from one audio source to another as described later in this chapter.









- 1 Audio source
- 2 Audio control buttons
- 3 Audio tile
- 4 Audio tools

Audio control buttons

Icon	Tuner	VHF	DVD	Playback
	Select to display the list of available sources			
	Select to select previous/next frequency Press and hold to tune in a channel		Select to rewind/play fast forward	Select to select previous/next track
	Select to select next/previous favorite channel		N/A	N/A
	N/A	N/A	Select to start	
	N/A	N/A	Select to pause playback	
	Select to display the volume slider			

Audio tools

Icon	Tuner	VHF	Playback
	Signal strength	N/A	N/A
	N/A	N/A	Select to toggle on/off repeat function. The icon is colored when the function is active.
	N/A	N/A	Select to toggle on/off shuffle mode. The icon is colored when the function is active.
	Select to display menus used for setting up zones and master control		
	Select to display the favorite stations for the tuner	Select to display the favorite channels for the VHF	Select to display the native menu for active source
	Select to display optional settings for active source		

Setting up the audio system

The speakers

Speaker zones

The NSS evo3 can be set up to control different audio zones. The number of zones depends on the audio server connected to your system.

You can adjust balance, volume and volume limit settings individually for each zone. Adjustments to the bass and tremble settings will alter all zones.

Master volume control

By default the volume for all speaker zones are adjusted when you adjust the volume. You can define which zones will be altered when you increase/decrease the volume.

Selecting tuner region

Before playing FM or AM radio, and using a VHF radio, you must select the appropriate region for your location.

Detaching Sirius from the AUX source

If a Sirius radio is connected to the FUSION radio/server, the AUX source is automatically attached to the Sirius feed. **Sirius** then appears in the source list when the FUSION server is active.

To use the AUX source for a different device, the Sirius must be detached from the AUX source.

→ **Note:** To use SiriusXM, an optional SiriusXM tuner must be connected to the FUSION server.

Operating the audio system

1. Select the Audio tile in the Instrument bar to activate the Audio overlay
2. Select the options icon and then select the audio server

3. Select the source icon and then select the audio source
 - Number of sources depends on the active audio server
4. Use the panel buttons to control your audio system

For an overview of audio control buttons and tools, refer to *"Audio control buttons"* on page 106 and *"Audio Tools"* on page 107.

For available options, refer to the documentation following your audio equipment.

Favorite channels

When a tuner or VHF channel is tuned in, you can add the channel to your favorite list. The favorite channels can be viewed, selected and deleted from within the Favorite list.

You can page through favorite channels by using the up/down audio panel buttons.

Sirius radio (North America only)

Channels list

The channels list displays all available Sirius channels, whether or not you have a subscription for the channel.

Favorites list

You can create a list of your favorite Sirius channels from within the channels list. You cannot add unsubscribed channels.

Locking channels

You can lock selected Sirius channels from being broadcasted. A 4-digit-code must be entered to lock channels and the same code entered to unlock the channels.

18

Weather

The system includes weather functionality that allows the user to view forecast data overlaid on the chart. This helps gaining a clear understanding of the weather conditions that are likely to appear.





The system supports weather data in GRIB format, available for download from various weather service suppliers.

The system also supports weather data from SIRIUS Marine Weather Service. This service is available only in North America.

Wind barbs

The rotation of the wind barbs indicate the relative wind direction, with the tail showing the direction the wind is coming from. In the graphics below, the wind comes from the northwest.

Wind speed is indicated by a combination of small and large barbs at the end of the wind tail.

	Zero knots / Indeterminate wind direction
	Small barb = 5 knots
	Large barb = 10 knots
	Arrow barb = 50 knots

If a combination of 5 and 10 knot barbs are shown on a tail, then add them together to give you the total wind speed. The example below shows 3 x large barb + 1 x small barb = 35 knots, and 60 knots indicated with 1 x arrow barb + 1 x large barb.

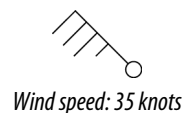

Showing weather details

If pop-up is enabled, you can select a weather icon to display the identity of the observation. If you select the pop-up, detailed information about the observation is displayed. You can also display the detailed information from the menu when the weather icon is selected.

GRIB weather

A GRIB file contains forecast information for a set number of days. It is possible to animate the weather data, which shows how weather systems are developing.

Importing GRIB data

GRIB data imported into memory can be displayed as chart overlay. Refer to "*Displaying GRIB weather as overlay*" on page 110. The file can be imported from any location that can be seen in the file manager.

→ **Note:** GRIB data that is imported overwrites the GRIB data in memory.

You can import the weather file using the File manager from the Tools panel or the Forecast menu option on the Chart panel:

- When you select a GRIB file with the File manager, the import option is available. Use it to import a GRIB file into memory.

Select the GRIB file to import the data.

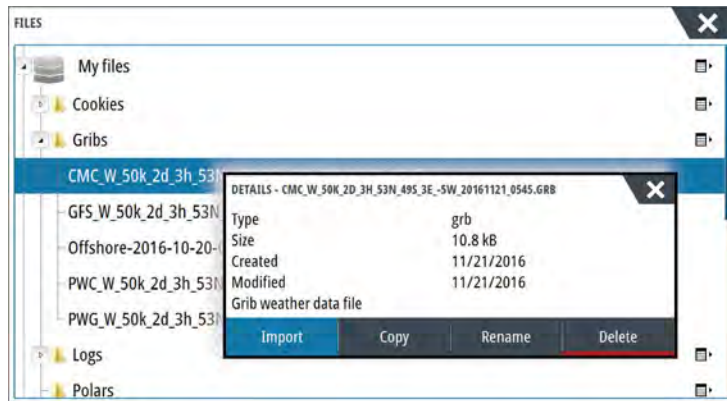

- Selecting the Forecast menu option on the Chart panel displays the GRIB weather dialog. Use the import file option in this dialog to open the File manager and import a GRIB file into memory. Using this dialog you can also select an available GRIB file. Selecting an available GRIB file is the same as importing the file into memory. Available GRIB files are files downloaded from a weather service supplier to the Gribs directory (in the Files manager).

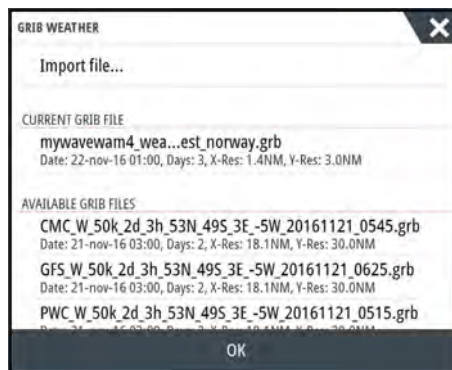

Displaying GRIB weather as overlay

Imported GRIB weather data can be displayed as an overlay on your chart panel.

When the GRIB weather overlay is selected, the chart menu increases to show GRIB weather options. From this menu you can select which weather symbols you want to display, set the distance between the barbs, and adjust the opaqueness of the weather symbols.

From this menu you can also animate the weather forecast. Refer to *"Animating GRIB weather forecast"* on page 111.

The Forecast menu option displays the GRIB file currently in memory and overlaid on the chart. Select the Forecast menu option to import a new GRIB file into memory. Importing a new file overwrites the GRIB data in memory.

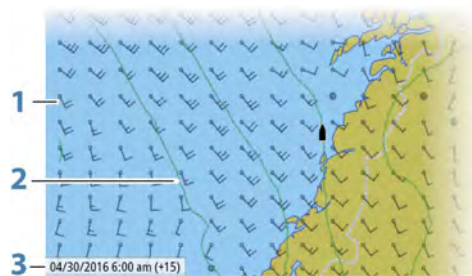
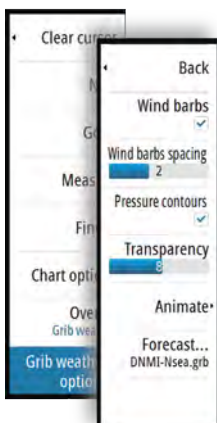

- 1 Wind barbs
- 2 Pressure contours
- 3 GRIB information window

GRIB information window

The GRIB information window shows the date and time for the GRIB weather forecast, and the selected forecast time in brackets. A negative value in the brackets indicates historic weather data.

If you select a position on the chart, the information window expands to include weather details for the selected position.

Animating GRIB weather forecast

The GRIB data contains forecast information for a set number of days. It is possible to animate the weather data and to show the predicted forecast for a specific time and date. The time scales vary depending on the file you are using.

The time shift is shown in brackets in the GRIB information window. The time is relative to the current time as provided by a GPS device connected to the system.

Select time and animation speed from the menu.

SiriusXM weather

When connected to a Navico Weather module, you can subscribe and include Sirius audio and Sirius Marine Weather Service on your system (North America only).

Depending on your selected subscription package, Sirius audio and weather service covers a variety of North American inland waters and coastal areas. For more information refer to www.siriusxm.com/marineweather

Sirius status panel

When the weather module is connected to the system, you get access to the Sirius status panel.

The status panel shows signal strength is indicated as 1/3 (weak), 2/3 (good) or 3/3 (preferred). It also includes antenna status, service level, and the electronic serial number for the weather module.

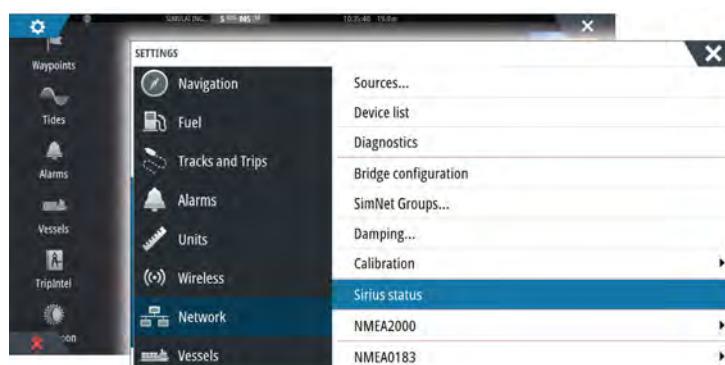

Sirius weather display

Sirius weather can be displayed as an overlay on your chart panel.

When weather overlay is selected, the chart menu increases to show the available weather options.

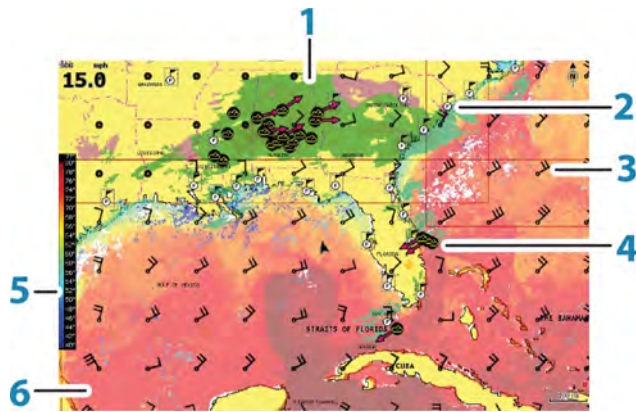

- 1 Precipitation color shading
- 2 City forecast icon
- 3 Wind barb
- 4 Storm icon
- 5 SST color bar
- 6 SST color shading

Use the Sirius weather option menu to select which weather symbology that should be displayed and how they should appear on the chart panel.

Sirius view options

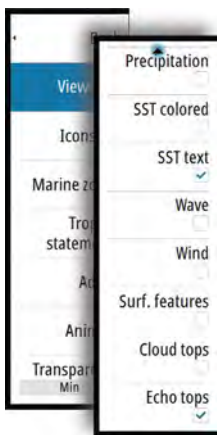

Precipitation

Shades of color are used to show precipitation type and intensity. The darkest color indicates the highest intensity.

Rain	From light green (light rain) - yellow - orange - to dark red (heavy rain)
Snow	Blue
Mixed	Pink

Sea Surface Temperature (SST)

You can show the sea surface temperature as color shading or as text.

When color coding is selected, the SST color bar is shown on the left side of the display.

You define how the color codes are used to identify sea surface temperature. See "*Adjusting color codes*" on page 114.

Wave indication

Colors are used to indicate forecasted wave height. The highest waves are dark red, while the lowest are blue.

You can define how the color codes are used to identify the wave height. Refer to "*Adjusting color codes*" on page 114.

Surface features

Turns surface features on/off. Surface features include fronts, isobars, and pressure points. Surface features cannot be shown at the same time as Wind.

Cloud tops

Turn Cloud tops on/off. Cloud tops indicate the height of the top of the clouds. The color palette used is grey with darker greys indicating lower clouds. Cloud tops cannot be shown at the same time as Precipitation or Echo Tops.

→ **Note:** This feature is only available for certain SiriusXM subscriptions.









Echo tops

Turns Echo tops on/off. Echo tops indicate the tops of storms. The color palette used is the same as for Precipitation. Echo tops cannot be shown at the same time as Precipitation or Cloud Tops.

→ **Note:** This feature is only available for certain SiriusXM subscriptions.

Weather icons

Several weather icons are available to show current or predicted weather conditions. You can select an icon to display detailed weather information.

	City forecast
	Surface observation
	Tropical storm tracking; past (grey) - present (red) - future (yellow)
	Hurricane (category 1-5) tracking; past (grey) - present (red) - future (yellow)
	Tropical disturbance/depression tracking; past (grey) - present (red) - future (yellow)
	Storm attributes
	Lightning
	Watch box location and warning
	Marine zone location

Local weather

Select the Local weather menu option to display the Local weather dialog. This dialog shows weather forecast and alerts for the area.

Select a time-slot tab to see the forecast for it.

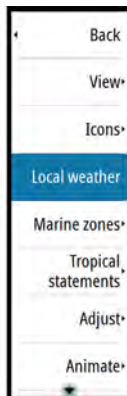

Marine zones

Depending on your selected subscription, SiriusXM services includes access to weather reports for U.S. and Canadian Marine Zones, with the exception of the high seas zones.

You can select a marine zone on a chart and view its forecast. You can also select a marine zone as your current zone of interest and you will be notified of any weather warnings in that zone.

Tropical statements

You can read tropical statements including information about tropical weather conditions. These statements are available for the entire Atlantic and the Eastern Pacific.

Adjusting color codes

You can define the sea surface temperature range and wave height color coding.

The temperature above warm and below cool values is displayed as progressively darker red and darker blue.

Waves higher than the maximum value are indicated with progressively darker red. Waves lower than the minimum value are not color coded.

Animating Sirius weather graphics

The NSS evo3 records the weather information you have turned on, and this information can be used to animate past or future weather conditions. The amount of information available in the system depends on the amount of weather activity; the more complex it is, the less time that is available for animation.

You can animate the past or the future, depending on which weather view you have turned on:

- With precipitation overlay, you can animate for the past and only assume weather conditions in the immediate future.
- With colored wave height overlay, you can animate the future (the predictions).

When activated, the time for the current graphic animation is displayed in the lower left corner of the chart panel.

Weather alarms

You can setup lightning or storm alarms to occur when the conditions are within a certain range of your vessel.

You can also set up an alarm as a severe weather forecast alarm issued for your chosen marine zone.

A watchbox is defined by the National Weather Service. When the alarm for watchbox is turned on, an alarm occurs when your vessel is entering or inside a watchbox.

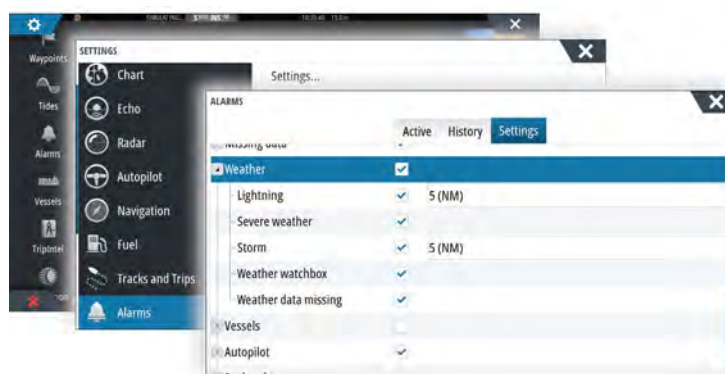
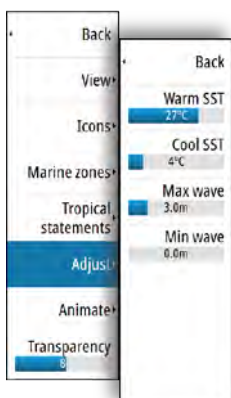

19

Video

The video function allows you to view videos or camera sources on your system.

→ **Note:** The video images are not shared from the Ethernet network. You can only view the video on the unit connected to the video source.

If a FLIR M-series camera is available on the Ethernet network, you can display the video and control the camera from the system.

For information about how to connect the camera, see the separate NSS evo3 Installation manual.

The Video panel

A video panel can be set up as a single panel, or as one of the panels on a multiple panel page.

The video image is proportionally scaled to fit into the video panel. Areas not covered by the image are colored black.

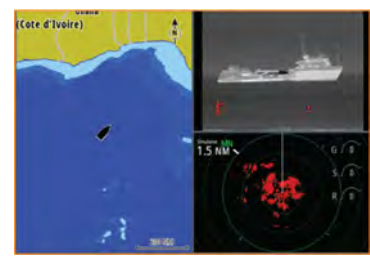

Setting up the video panel

Video source

NSS evo3 supports two video input channels. You can select to view one channel only, or to cycle the image between available video cameras.

The cycle period can be set from 5 to 120 seconds.

Video standard

NSS evo3 supports NTSC and PAL video. Check the local video standard or the standard of your cameras.

Adjusting the video image

You can optimize the video display by adjusting the video image settings. The settings are adjusted individually for each video source. Default for all settings: 50%.

FLIR camera control

When the connection is established to a FLIR camera, the menu changes to include access to FLIR camera controls.

→ **Note:** You can take over camera control from any NSS evo3 connected to the Ethernet network.

Establishing connection with the FLIR video camera

When a video panel is active, the NSS evo3 automatically recognizes a FLIR camera if it is available on the network.

→ **Note:** When there is a DHCP server present on the Ethernet network, the FLIR camera needs to be configured and set to have a Static IP Address before the connection can be established. For instructions on how to configure your specific FLIR camera model, refer to FLIR documentation.

→ **Note:** Only one FLIR camera can be connected to the Ethernet network.

When you activate a video panel, the system starts searching the network for a FLIR camera.



Lost connections are indicated by a panel key. Select this key to reestablish the connection. When the connection is established the menu changes to include access to FLIR camera control.

→ **Note:** You can take over camera control from any NSS evo3 unit connected to the Ethernet network.

Panning and tilting the FLIR camera

When the connection to the FLIR camera is established, pan and tilt panel buttons appear on the video panel. The left and right arrow buttons control the camera's pan. The up and down arrow buttons tilt the camera.

Select one of the arrow buttons on the panel to control the camera. The camera continues to move for as long as you press the button.

Zooming the FLIR video image

You zoom the video image by using the zoom panel buttons.

There are two zoom options available, depending upon your selected FLIR camera source option:

- **Digital zoom**
Only available when the camera is in Infrared mode. In this mode, the zoom is represented in levels (0, 2 and 4 times zoom). Each press on a zoom button increments or decrements the zoom level.
- **Optical zoom**
Available in daylight mode. In this mode, the camera continues to zoom for as long as you press a zoom panel button.

The FLIR camera source options

The FLIR camera includes both daylight and infrared video sources.

When the infrared source is selected, the following options are available:

- **Toggle color scheme**
Cycles through FLIR's video output color scheme. Each of these schemes maps a different color to a different temperature.
- **Toggle polarity**
Inverts the color scheme. For example, instead of: White = Hot and Black = Cold, it becomes Black = Hot and White = Cold.

The FLIR camera's home position

You can set the current pan and tilt position as the camera's home position.

You can later quickly return to this camera position.

20

Time plots

The NSS evo3 can present data history in different plots. The plots can be displayed in full page, or combined with other panels.

The Time plot panel

The Time plot panel consists of two predefined layouts. You switch between the layouts by selecting the left and right panel arrows. You can also select the layout from the menu.

You can select which data to present on a time plot panel, and you can define the time range for each plot.

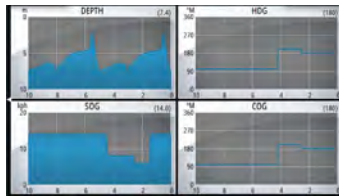

Layout 1

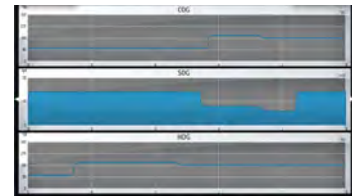

Layout 2

Missing data

If the data is unavailable, the relevant plot turns into a dashed line and flattens out at the point the data was lost. When the data becomes available again, a dashed line joins up the two points showing an average trend line bridging the missing data.

Selecting data

Each data field can be changed to show the preferred data type and the time range.

1. Select the edit option from the menu
2. Activate the field you want to edit
3. Change the information type and eventually the range
4. Save your changes

The data available for the Time plots are by default the sources used by the system. If more than one data source is available for a data type you can select to show alternative data source in the Time plot. You change the data type by using the data source option in the menu.

21

Alarms

Alarm system

The system continuously checks for dangerous situations and system faults while the system is running. When an alarm situation occurs, an alarm message pops up on the screen.

An alarm icon is displayed in the status bar, and the status bar pulses the color of the alarm.

If you have enabled the siren, the alarm message is followed by an audible alarm, and the switch for external alarm becomes active.

The alarm is recorded in the alarm listing so that you can see the details and take the appropriate corrective action.

Type of messages

The messages are classified according to how the reported situation affects your vessel. The following color codes are used:

Color	Importance
Red	Critical
Orange	Important
Yellow	Standard
Blue	Warning
Green	Light warning

Single alarms

A single alarm is displayed with the name of the alarm as the title, and with details for the alarm.

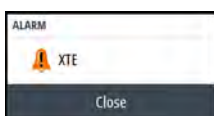

Multiple alarms

If more than one alarm is activated simultaneously, then the alarm message displays a list of up to 3 alarms. The alarms are listed in the order they occur with the alarm activated first at the top. The remaining alarms are available in the Alarms dialog.



Acknowledging a message

The following options are available in the alarm dialog for acknowledging a message:

- **Close**
Sets the alarm state to acknowledged, meaning that you are aware of the alarm condition. The siren / buzzer stops and the alarm dialog is removed. However, the alarm remains active in the alarm listing until the reason for the alarm has been removed.
- **Disable**
Disables the current alarm setting. The alarm does not show again unless you turn it back on in the Alarms dialog.

There is no time-out on the alarm message or siren. They remain until you acknowledge the alarm or until the reason for the alarm is removed.

Alarms dialog

All alarms are setup in the Alarms Settings dialog.



The alarm dialogs can also be activated from the Tools panel. The alarm dialogs include information about active alarms and alarm history.

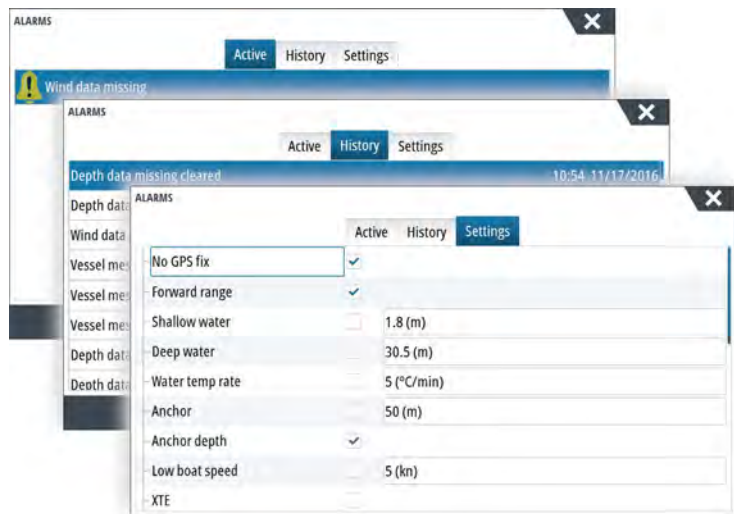
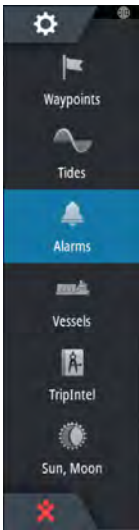

22

Tools

By default, the Tools panel includes icons used for accessing options and tools that are not specific to any panel.

When external equipment is integrated to the unit, new icons might be added to the Tools panel. These icons are used for accessing the external equipment's features.

Waypoints

List of waypoints, routes, and tracks with details.

Select the waypoint, route, or track you wish to edit or delete.

Tides

Displays tide information for the tide station nearest to your vessel.

Select the arrow panel buttons to change the date, or select the date field to access the calendar function.

Available tide stations can be selected from the menu.

Alarms

Active alarms

List of active alarms.

Alarm history

List of all alarms with time stamp.

Alarm settings

List of all available alarm options in the system, with current settings.

Vessels

Status listing

List of all AIS, MARPA, and DSC vessels with available information.

Message listing

List of all messages received from other AIS vessels with time stamp.

TripIntel

Provides trip management functionality and trip information. For more information, refer to "*TripIntel*" on page 46.

Sun, Moon

Displays sunrise, sunset, moonrise and moonset for a position based on entered date and the position's latitude/longitude.

Files

File management system, used to browse the contents of the unit's internal memory and inserted SD card.

Viewing files

Select a file in the Files panel and then the view file option in the **Details** dialog.

Copying files to a card in the card reader

You can copy screen captures and logs to a card in the card reader. You can also export System Settings, Waypoints, Routes, and Tracks to a card. Exporting files is covered in the section "*Maintenance*" on page 124.



Find

Search function for chart items (waypoints, routes, tracks, etc.).

GoFree Shop

→ **Note:** The built-in wireless functionality must be connected to an external wireless hotspot in order to access the GoFree Shop. Refer to "*Connect and disconnect from a wireless hotspot*" on page 95.

Opens the GoFree Shop web site. At the GoFree Shop you can browse, purchase, and download compatible charts for your system. You can also upload your Echosounder logs to be shared on Social Map charts. When you log on, the system automatically gives you a notification if a new software version is available for your system. If an update is available, you can download it to a card slot or defer the download until later.

23

Simulator

The simulation feature lets you see how the unit works in a stationary position and without being connected to other devices.

The status bar indicates if the simulator is toggled on.

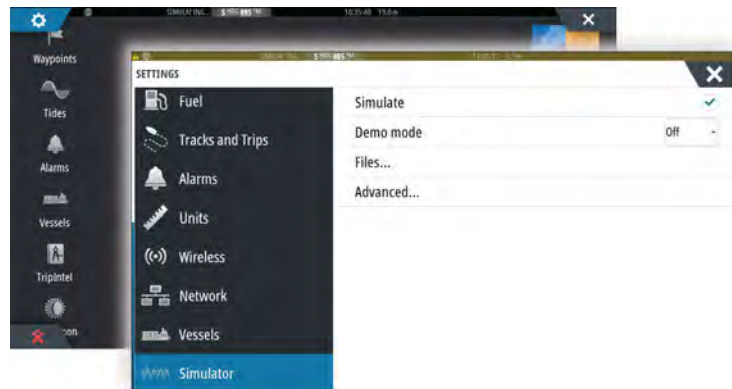

Demo mode

In this mode the unit automatically runs through the main features of the product; it changes pages automatically, adjusts settings, opens menus, etc.

If you tap on a touchscreen or press a key when demo mode is running, the demonstration pauses. After a time-out period, demo mode resumes and any changed settings are restored to default.

→ **Note:** Demo mode is designed for retail/showroom demonstrations.

Simulator source files

You can select which data files are used by the simulator. A set of source files is included in your system, and you can import files by using a card inserted into the card reader. You can also use your own recorded log data files in the simulator.

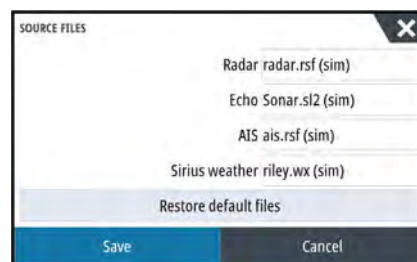

Advanced simulator settings

The Advanced simulator settings allows for manually controlling the simulator.



GPS source

Selects where the GPS data is generated from.

Speed, Course and Route

Used for manually entering values when GPS source is set to Simulated course or Simulated route. Otherwise, GPS data including speed and course come from the selected source file.

Set start position

Moves your vessel to the current cursor position.

→ **Note:** This option is only available when the GPS source is set to Simulated course.

24

Maintenance

Preventive maintenance

The unit does not contain any field serviceable components. Therefore, the operator is required to perform only a very limited amount of preventative maintenance.

It is recommended that you always fit the supplied protective sun cover when the unit is not in use.

Cleaning the display unit

A proper cleaning cloth should be used to clean the screen, where possible. Use plenty of water to dissolve and take away salt remains. Crystallized salt may scratch the coating if using a damp cloth. Apply minimal pressure to the screen.

Where marks on the screen cannot be removed by the cloth alone, use a 50/50 mixture of warm water and isopropyl alcohol to clean the screen. Avoid any contact with solvents (acetone, mineral turpentine, etc.), or ammonia based cleaning products, as they may damage the anti-glare layer or plastic bezel.

To prevent UV damage to the plastic bezel, it is recommended that the sun cover be fitted when the unit is not in use for an extended period.

Cleaning the media port door

Clean the media port door regularly to avoid salt crystallization on the surface, causing water to leak into the card slot.

Checking the keys

Make sure that no keys are stuck in the down position. If one is stuck, wiggle the key to free it back to normal.

Checking the connectors

The connectors should be checked by visual inspection only.

Push the connector plugs into the connector. If the connector plugs are equipped with a lock, ensure that it is in the correct position.

NMEA Data logging

All serial output sentences sent over the NMEA TCP connection are logged to an internal file. You can export and review this file for service and fault finding purposes.

The maximum file size is predefined. If you have added several other files to the system (file recordings, music, pictures, PDF files), this may reduce the allowed file size for the log file.

The system logs as much data as possible within the file size limitation, and then it starts overwriting the oldest data.

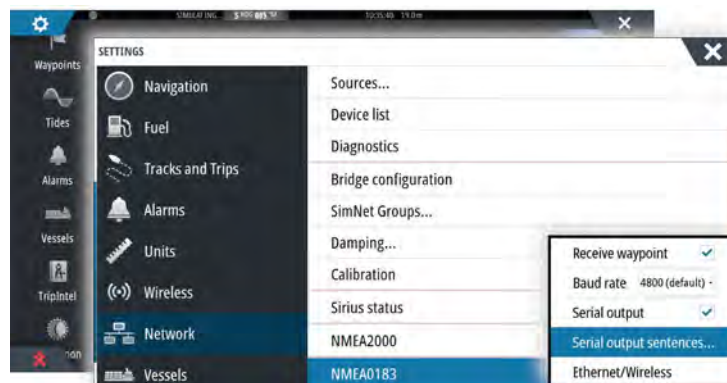

Exporting the log file

The log file can be exported from the files dialog.

When you select the Log database you are prompted to select a destination folder and filename. Once accepted, the log file is written to the chosen location.

RSD sentence output

The output of RSD NMEA 0183 message can be enabled (default off) to provide cursor position information to an external device. The cursor position information may be used by devices such as thermal cameras with pan-tilt ability, and external radar displays.

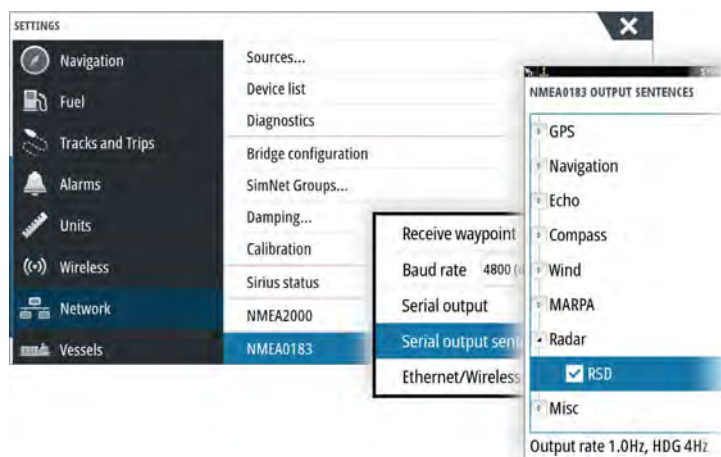

→ **Note:** The sentence format (dictated by NMEA 0183) was not written to take in to consideration dual radar systems, and therefore does not transmit identification information to distinguish between sources. When two radar PPIs are shown on the screen at the same time, only the first (left hand) radar provides RSD information. **RSD** is shown on the radar PPI to indicate this feature is enabled.

Software upgrades

The latest software is available for download from our website, www.simrad-yachting.com.

Before initiating an update to the unit itself, be sure to back up any potentially valuable user data. Refer to "*Backing up your system data*" on page 126.

The system or the Network analyzer and service assistant can advise software updates are available.

Network analyzer and service assistant

The system has a built-in service assistant that creates a report of the devices installed on the NMEA 2000 and Ethernet network such as the software versions, serial numbers, and information from the settings file to assist in technical support enquiries.

To use the analyzer, open the About page of the System settings dialog and select Support. Two options are displayed:

Create report

Analyzes your network and prompts you for information required for support and creates the report with information automatically gathered from the network. You can add screenshots and log files that will be attached to the report. There is a 20MB limit for the report attachments. You can save the report to a memory card and email it to support or upload it directly if you have an internet connection. If you call technical support first, you can enter an incident number to assist with tracking.

Check system for updates

Analyzes your network and checks if updates are available for compatible devices.

→ **Note:** Connect your unit to the internet to check for the latest available software versions. The software versions will be up to date as of the last time you updated your unit or connected to the internet.

Update software

- **Note:** Remove any mapping cards from your unit and install a memory card with sufficient storage before downloading software updates or creating and saving reports to the memory card.
- **Note:** Do not turn off the MFD or device until the update is completed or you are prompted to restart the unit or device being updated.
- 1. If your MFD is connected to the Internet, you can download the software update from the **Updates Dialog** into a memory card. You can also download the software update from www.simrad-yachting.com to a memory card inserted in a smart device or PC connected to the internet.
- 2. Insert the card containing the software updates in your MFD.
- 3. Select the item to be updated in the **Updates Dialog** and follow the prompts.

As you respond to the prompts the update occurs. Prompts may request that you restart the device to complete the update. You can restart devices to complete the update later at a more convenient time.

Backing up your system data

Waypoints, Routes, and Tracks that you create are filed in your system. It is recommended to regularly copy these files and your system settings files as part of your back-up routine. The files can be copied to a card inserted in the card reader.

There are no export file format options for the system settings file. The following output formats are available for exporting Waypoints, Routes, and Tracks files:

- **User Data File version 5**
This is used to import and export waypoints and routes with a standardized universally unique identifier (UUID), which is very reliable and easy to use. The data includes such information as the time and date when a route was created.
- **User Data File version 4**
This is best used when transferring data from one system to another, since it contains all the extra bits of information these systems store about items.
- **User Data file version 3 (w/depth)**
Should be used when transferring user data from one system to a legacy product (Lowrance LMS, LCX)
- **User data file version 2 (no depth)**
Can be used when transferring user data from one system to a legacy product (Lowrance LMS, LCX)
- **GPX (GPS Exchange, no depth)**
This is the format most used on the web that shares among most GPS systems in the world. Use this format if you are taking data to a competitor's unit.
- **Northstar.dat (no Tracks)**
Used to transfer data to a legacy Northstar device.

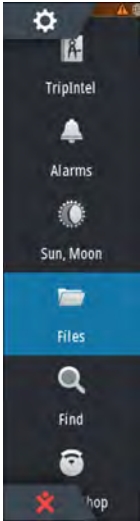

Export all Waypoints, Routes and Tracks

Use the export option if you want to backup all Waypoints, Routes, Tracks and Trips on your system.

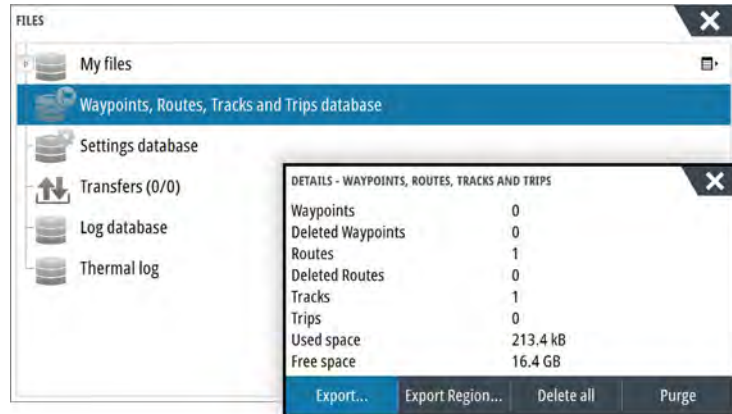

Export region

The export region option allows you to select the area from where you want to export data.

1. Select Export region
2. Drag the boundary box to define the desired region



3. Select the export option from the menu
4. Select the appropriate file format
5. Select the serial port field to start the export

Purging Waypoints, Routes and Tracks

Deleted Waypoints, Routes and Tracks are stored in the display unit's memory until the data is purged. This is necessary to allow user data to be synchronized across multiple units on an Ethernet network. If you have numerous deleted, unpurged Waypoints, purging may improve the performance of your system.

→ **Note:** When user data is purged from the memory, it cannot be recovered.

Index

A

Active panel 17
Adjusting panel size 19
AIS 98
 Calling a vessel 99
 DSC 99
 Icon filters 101
 Icon orientation 102
 Information on radar panels 99
 Searching for AIS items 98
 Target symbols 98
 Viewing information about targets 98, 99
AIS SART 99
 Alarm message 100
Alarm system 118
Alarm
 Critical Zone 92
Alarms
 Acknowledging 118
 Alarm settings dialog 118
 Multiple alarms 118
 Single alarm 118
 Type of messages 118
App
 GoFree Link 95
Application pages 11
Arrival alarm 45
Arrival radius 44
Audio 104
 Control buttons 106
 Detaching Sirius 107
 Enable 104
 Favorite channels 108
 Master volume control 107
 Operating 107
 Selecting tuner region 107
 Setting up the system 107
 Sirius radio 108
 Speaker zones 107
 Speakers 107
Audio
 Panel 106
Audio tools 107
Autopilot 50
 Activating 50
 AP24/28 systems 57
 AUTO mode 52
 Autopilot panel 51
 Autopilot pop-up 50
 Autopilot tile in Instrument bar 51
Chart compass 61
Depth contour tracking 56
Dodging 53
EVC system 57
Follow-up steering 52
Gybing 55
Indication in Status bar 50

Indication on pages 50
Locking remote stations 57
Modes 52
Non-Follow up mode 52
Standby (STBY) mode 52
Switching to manual steering 50
Tacking in AUTO mode 52
Tacking in WIND mode 55
Turn pattern steering 55
Waypoint arrival circle 54
WIND mode 54
Autorouting, see Dock-to-dock
Autorouting 38
Autorouting
 Dock-to-dock 38

B

Backing up your system data 126
Bottom lock 80
Bridge Control 22
 Adding displays 22
 Bridge presets 24
 Configuring the preset pages 23
 Page configurations 22

C

C-MAP chart options 30
Card
 Copying files to 120
Charts 25
 3D charts 28
 C-MAP chart options 29
 Chart compass 61
 Chart data 25
 Chart panel 25
 Chart scale 26
 Course up 26
 Creating routes 28
 Dual charts 25
 Embedded cartography 25
 Find chart objects 28
 Heading up 26
 Insight chart options 29
 Look ahead 26
 Measuring distance 27
 Navionics chart options 32
 North up 26
 Orientation 26
 Overlay 29
 Panning 26
 Positioning the vessel on the chart panel 26
 Radar overlay source 64
 Selecting chart type 26
 Settings 35
 Using the cursor 27
 Vessel symbol 26
 Zooming 26

- Charts
 - Symbol 26
- Connect
 - Smartphone and tablet 95
 - Wireless hotspot 95
- Controller and viewer app
 - GoFree Link 95
- Converting tracks to routes 39
- Coordinate system 45
- Copying files to a card 120
- Critical Depth 92
- Critical Forward Range 92
- Critical Zone alarm 92
- Cursor assist 27, 65, 75, 84
 - Customize the long press feature 19
- Customizing your system 19
- CZone 13

D

- Dangerous vessels 102
- Dashboards 103
- Datum 45
- DCT 56
- Demo mode 122
- Depth line 80
- Depth offset 93
- Dialog boxes 17
- Disconnect
 - Wireless hotspot 95
- Display illumination 15
- Dock-to-dock Autorouting
 - Entire route 38, 39
 - Example 39
 - Selection 38, 39
- Dual Radar 63
- Dual range, Radar 65

E

- Easy Routing 38
 - Example 39
- EBL/VRM markers 70
- Echosounder 74
 - A-Scope 80
 - Depth offset 93
 - Fish ID 80
 - Image 74
 - Pausing 77
 - Ping speed 78
 - Scroll speed 78
 - Split screen 80
 - Start recording echosounder data 78
 - Stop recording log data 79
 - Structure options 77
 - Using the cursor 75
 - View history 76
 - View options 79
 - View recorded data 79
 - Zoom bar 74
 - Zoom bars 80

- Zooming 74
- Echosounder
 - Split Zoom 80
- Export region 127
- Extension lines 102

F

- Favorite pages 12
 - Adding new 20
 - Edit 21
- Favorites 18
- Files to a card, copying 120
- Files, management 120
- Files
 - Viewing 120
- Find items tool 121
- First time startup
 - Setup wizard 15
- FLIR camera
 - Controlling 115
 - Digital zoom 116
 - Establishing connection 115
 - Home position 116
 - Integration 13
 - Optical zoom 116
 - Panning and tilting 116
 - Source options 116
 - Zooming 116
- ForwardScan 90
 - Critical Depth 92
 - Critical Forward Range 92
 - Critical Zone alarm 92
 - Heading extension 91
 - Image 90
 - Installation 82
 - Setup 92
 - Transducer angle 93
- Frequency 76
- Fuel economy gauge 22
- FUSION-Link 13, 104

G

- Go to cursor 27, 65, 75, 84
- GoFree
 - Shop 95
 - Wireless connection 95
- GoFree
 - Link 95
 - Smartphone connection 96
 - Tablet connection 95
- Great circle 44
- GRIB weather 109
 - Animated weather forecast 111
 - Importing data 109
 - Information window 111
 - Overlay on chart panel 110

H

- Home page background 19

I

- Illumination 15
- Improving system performance 127
- Insight chart options 30
- Instrument bar 21
 - Activity bar 21
 - Appearance 21
 - Edit the content 21
 - Fuel economy gauge 22
 - Turning on/off 21
- Instrument panels 103
- Integration of 3rd party devices 12
- Internet usage 4

L

- Locking the touchscreen 16
- Long press feature
 - Customize 19

M

- Magnetic variation 45
- Man Overboard
 - Cancel navigation to MOB 18
 - Creating a MOB 18
 - Delete a MOB waypoint 18
- Manual
 - About 4
 - Version 4
- Manuals, viewing 5
- Measuring distance 27, 75, 84
- Menus 17
- MMSI number 101

N

- Navigate 42
 - Arrival alarm 45
 - Arrival radius 44
 - Cancel navigating a route 44
 - Datum 45
 - Methods 44
 - Great circle 44
 - Rhumb lines 44
 - Nav panel 42
 - Panels 42
 - Position panel 42
 - Routes 43
 - To cursor position 43
 - With autopilot 44
- Navigation settings 44
- Navionics chart options 32
- NMEA Data logging 124
- NMEA
 - Exporting log file 125
- Noise rejection 77

O

- Operation
 - Touch 16

- Overlay downscan 81

P

- Pages
 - Selecting a page 17
 - Selecting active panel 17
- Palettes 80, 85
- Panels
 - Adjusting panel size 19
- Password protection 20
- PDF, viewing files 5
- Phantom Loran 45
 - Settings 45
- Pin code
 - Password protection 20
- Ping speed 78
- PPI 69
- Preventive maintenance 124
- Purging 127

R

- Radar 63
 - Alarm settings 71, 72
 - Course up 69
 - Dual 63
 - Dual range 65
 - EBL/VRM markers 70
 - EBL/VRM
 - Placing 70
 - EBL/VRM
 - Fast scan 69
 - Gain 67
 - Guard zone 71
 - Heading up 69
 - Interference 68
 - MARPA
 - Target symbols 71
 - Targets 71
 - Tracking targets 72
 - View target info 72
 - North up 69
 - Offset 70
 - Operational modes 64
 - Orientation 69
 - Overlay 64
 - Palette 69
 - Position radar center 69
 - PPI 69
 - Radar overlay source 64
 - Radar panel 63
 - Rain clutter 68
 - Range 64
 - Recording data 72
 - Sea clutter 68
 - Sea State 69
 - Sensitivity 71
 - Settings 73
 - Source 64
 - Target boost 69

- Target expansion 68
 - Target trails 69
 - Threshold 68
 - True motion 70
 - Range 76
 - Record echosounder data 86
 - Recording
 - Start recording echosounder data 78
 - Start recording log data 78
 - Rhumb lines 44
 - Routes 38
 - Converting tracks to routes 39
 - Creating a new route on the chart panel 38
 - Creating a route from existing waypoints 39
 - Dialog 41
 - Dock-to-dock Autorouting 38
 - Easy Routing 38
 - Edit in chart panel 38
 - Edit Route dialog 40
 - Navigate 43
- S**
- Saving waypoints 28, 37, 65
 - Screen capture 18
 - Scroll speed 78
 - Sea State 69
 - Setup wizard
 - First time startup 15
 - Simulator 122
 - Demo mode 122
 - Source files 122
 - Sirius radio 108
 - Channels list 108
 - Favorite list 108
 - Locking channels 108
 - Sirius weather
 - Animated weather graphics 114
 - Color codes 114
 - Marine zones 113
 - Overlay on chart panel 111
 - Precipitation 112
 - Sea Surface Temperature (SST) 112
 - Status panel 111
 - Tropical statements 114
 - Wave indication 112
 - Weather icons 113
 - SiriusXM weather 111
 - SL2 format 78
 - SL3 format 78
 - SLG format 78
 - SmartCraft VesselView 13
 - Smartphone connection 96
 - Software upgrade 125
 - Software version 5
 - Software
 - How to update 126
 - SonicHub 104
 - Speaker zones 107
 - Speakers 107
 - Speed and course indication 102
 - Split pages 12
 - Pre-configured 12
 - Split screen
 - Echosounder 80
 - Split zoom
 - Echosounder 80
 - StructureMap 79, 87
 - Activate 87
 - Image 87
 - Live source 87
 - Mapping cards 88
 - Options 88
 - Saved files 88
 - Sources 87
 - Tips 88
 - StructureScan 83
 - Advanced settings 86
 - Auto range 85
 - Contrast 85
 - Convert data to StructureMap format 88
 - Custom range 85
 - Flipping the image 86
 - Frequencies 85
 - Image 83
 - Noise rejection 89
 - Pausing the image 85
 - Preset range levels 85
 - Range 85
 - Range lines 86
 - Recording data 88
 - Using the cursor 84
 - View down or side scan 85
 - View history 85
 - View options 83
 - Zooming 83
 - System Controls dialog 15
 - System Settings
 - Coordinate system 45
 - Datum 45
 - Magnetic variation 45
- T**
- Tablet connection
 - GoFree, wireless 95
 - Temperature graph 80
 - Time plot panel 117
 - Missing data 117
 - Time plots 117
 - Selecting data 117
 - Tools 120
 - Tools
 - Find items 121
 - Touch
 - Operation 16
 - Touchscreen
 - Locking 16
 - Tracks

- Dialog 41
- Tracks
 - Creating new 40
- Transducer angle, ForwardScan 93
- Trip management 46
- Triptel 46
- Turn pattern steering
 - Autopilot 55
- Turning the unit on and off 15
- TVG 78, 86

U

- Unit
 - Checking the connectors 124
- Update software 126

V

- Vessel alarms 100
- Vessel settings 101
- Video 115
 - Adjusting the image 115
 - Setting up the panel 115
 - Source 115
 - Standard 115
- Video
 - Video panel 115
- View Echosounder log 81
- Viewing files 120

W

- Wallpaper, customizing 19
- Warranty 4
- Waypoints, routes and tracks
 - Purging 127
- Waypoints, routes, trails and trips
 - Export 127
- Waypoints 37
 - Alarm settings 37
 - Dialog 41
 - Edit 37
 - Moving 37
 - Saving 28, 37, 65
- Weather 109
 - Alarms 114
 - Showing weather details 109
- WheelKey
 - Configure 19
- Wind barbs 109
- Wireless hotspot
 - Connect and disconnect 95
- Wireless
 - Devices details 97
 - Smartphone connection 96
 - Tablet connection 95

X

- XTE limit 45
- xtf format 78



SIMRAD